

# Harmonic Analysis Fundamentals

## Basics of Harmonic Analysis

### Introduction

In this course we will discuss the underlying concepts of harmonic analysis in relation to industrial and commercial power systems. Also included will be the reasons we require this analysis, the recognition of problems that may arise in the process, methods of correcting and preventing these issues, the data required to perform this analysis, and the benefits of technology in performing a harmonic analysis study.

The main source of power system harmonics has traditionally been the static power converter, used as a rectifier in many industrial processes. The static power converter is now used in a number of different applications. These include adjustable speed drives, frequency changers for induction heating, switched-mode supplies, and many more. Increasingly, semiconductor devices are being used as static switches to adjust the amount of voltage being applied to a load. Some applications for this include light dimmers, electronic ballasts for discharge lamps, soft starters for motors, and static var compensators. Any device with a nonlinear voltage current like an arc furnace or saturable electromagnetic device can also be included.

Nonlinear loads represent a growing portion of the total load of a commercial or industrial power system. This means harmonic studies are an important part of any system design and operation. Fortunately, the software available to assist us with harmonic analysis has grown also.

If we model power system impedances as a function of frequency, we can determine the effect of harmonic contributions produced by nonlinear loads on voltage and current in a power system. The majority of harmonic analysis software will offer the ability to do as follows:

- Calculate harmonic bus voltages and branch current flows produced by harmonic sources in a network
- See resonances in an existing or planned system

- Calculate the effects of harmonics on voltage or current waveform distortion or telephone interference through performance indices. This can also aid in finding capacitors and passive filters to produce optimal system performance.

We will discuss the details of applicable standards and system modelling, particularly in industrial and commercial systems running at low or medium voltages. The basics are applicable also to higher voltage systems and other system applications. In this course, we will not cover active filters as part of a design, but some references will be made to their use and application.

From the beginning we may say that harmonic filter design is linked closely to power-factor (PF) requirements in a system, based on utility tariffs. Both must therefore be considered together. Many studies on PF compensation have previously been made without considering possible resonances or harmonic absorption by capacitors.

## **Background**

By definition, any device or load that doesn't draw a sinusoidal current when excited by a sinusoidal voltage of the same frequency is a nonlinear load. Most commonly these are switching devices like solid-state converters which force conduction of currents for particular periods. They can also include saturable impedance devices like transformers with nonlinear voltage vs. impedance characteristics. Nonlinear loads are also considered sources of harmonic currents, in which harmonic frequencies are classed as integer multiples of the system frequency. Arc furnaces, cycloconverters, and other specific nonlinear loads can have non-integer harmonic frequencies as well as the integer harmonics expected in the system.

Harmonics are a part of every fundamental current cycle. When calculating them, they are considered part of the steady-state solution. But harmonics can vary from cycle to cycle, as exceptions will always occur. These are classed as time-varying harmonics. These are neither dealt with in this chapter, nor are quasisteady-state or transient solutions (as in magnetization inrush current of a transformer). In industrial application studies, the nonlinear load or harmonic source is classed as an ideal current source without a Norton's impedance (i.e. assume infinite Norton

impedance), providing a constant current, regardless of the system impedance seen by the source. This is generally a reasonable assumption and tends to yield acceptable results. A Norton equivalent current source can still be used when a nonlinear device acts as a voltage source, such as with pulse-width-modulated or PWM inverters, as most computer software works on the current injection method.

Networks are solved for current and voltage individually at each frequency, as a system is subjected to current injections at multiple frequencies. Then, the total voltage or current can be found through a root-mean-square or arithmetic sum via the principle of superposition.

Different types of nonlinear loads will generate different harmonic frequencies. Most will produce odd harmonics, with small, even harmonics, but loads like arc furnaces produce the entire spectrum: odd, even, and non-integer, also known as interharmonics. In general, the harmonic amplitude will decrease as the harmonic order or frequency increases.

Depending on harmonic voltage drops in various series elements of the network, distortion of the voltage waveform is produced due to the effects of harmonic current propagation through the network (including the power source). Voltage distortion at a bus depends on the equivalent source impedance – smaller impedance means better quality voltage. Note that nonlinear loads of harmonic sources are not power sources, but the cause of active and reactive losses of power in a system.

### **The Purpose of a Harmonic Study**

Nonlinear loads represent a growing propagation in commercial buildings and industrial plants, in the range of thirty to fifty percent of the total load. This means we need to examine the effects of harmonics within a system and the impact they have on a utility and neighbouring loads, to prevent any complaints, equipment damage, or loss in production.

The list below represents a number of situations in which a harmonic study may be necessary, including recommendations for mitigation of harmonic effects.

- a) IEEE Std. 519-1992 compliance, defining the current distortion limits that should be met in the utility at the point of common coupling or PCC. As a basis for the system design, limits of voltage distortion are also defined. These are intended to provide a good sine wave voltage in the utility, but users are expected to use them as a basis for the design of a system. If current distortion limits are met, voltage distortion limits should also be met, allowing for unusual and exceptional circumstances.
  
- b) Harmonic related problems in the past, including failure of power-factor compensation capacitors; overheating of transformers, motors, cables, and other such equipment; and misoperation of protective relays and control devices.
  
- c) Expansion in which significant nonlinear loads are added, or a significant capacitance is added to a plant.
  
- d) Designing a new power system or facility in which the power factor compensation, load-flow, and harmonic analyses need to be studied in one integrated unit, in order to determine reactive power demands, harmonic performance limits, and how to meet these requirements. If system problems appear to be caused by harmonics, it becomes important to determine resonant frequencies at points which are causing problems. Parallel system resonance can also occur around the lower harmonic orders (3, 5...) with banks of power-factor correction capacitors. This can be critical if a harmonic current injection at that frequency excites the resonance.

Frequently you will find systems where taking harmonic measurements as a tool for diagnostics rather than performing detailed analysis studies will be a much more practical task. Measurements can also be used to verify system models before performing a detailed harmonic analysis study. Arc furnace installations are a situation in which this is especially desirable. Careful consideration must be given to procedures and test equipment to make sure harmonic measurements will produce reliable results. These may produce the cause of a problem, meaning a simpler study or even the elimination of the need for a study.

## Harmonic Sources

Harmonic sources are all considered nonlinear loads, as when a sinusoidal voltage is applied, they draw non-sinusoidal currents. This may be caused by the inherent characteristics of the load as in arc furnaces, or due to a switching circuit like a 6-pulse converter, which forces conduction for particular periods. There may be many such harmonic sources throughout an industrial or commercial power system.

Harmonic studies require that the performer has knowledge of harmonic currents produced by the involved nonlinear loads. An analytical engineer has three main choices.

- Measuring harmonics produced at each source
- Calculating harmonics produced via a mathematic analysis in applicable situations; e.g. converters or static var compensators
- Using typical values from published data on similar applications

All three of these methods are used in practice and acceptable results are produced by each.

System configuration and loads are continually changing. This means that the harmonics also change, and studying all possible conditions would be a difficult task. Instead, designs are based on the “worst-generated” harmonics, by finding the worst operating condition available. However, even with this case, harmonic flows through various parts of a network can be different, depending on tie breakers or transformers involved. Even with the “worst-generated” case, this means we must also analyse the “worst operating case(s)”.

When multiple harmonic sources are connected to the same or different buses, another difficulty arises in the analysis. Phase angles between same order harmonics are usually unknown. This means that we generally have to turn to arithmetic addition of harmonic magnitudes, assuming the sources are similar, with similar operating load points. If sources are different, or operate at different load points, this approach can produce more conservative filter designs or distortion

calculations. For common industrial applications, determining phase angles of harmonics and vectorial addition is often not very cost-effective and can be over-complicated, but this can be resolved by simplifying assumptions through field measurements or previous experience. When accuracy is more important, such as in high-voltage DC transmission and other utility applications, more advanced techniques are employed.

Industrial harmonic studies are usually based on the assumption that a positive sequence analysis applies, and a system is balanced. This means they are represented on a single-phase basis. If the system or load is extremely unbalanced, or a four-wire system exists with single-phase loads, this warrants a three-phase study. This situation makes it appropriate and preferred to find the harmonics generated in all three phases. A three phase study, however, may not serve the full purpose of the study if harmonic generation is assumed to be balanced, while the system is unbalanced. The cost of one of these studies can be much higher than a single-phase study, so it should only be used if it is justifiable to produce this expense for this purpose.

### **Effects of Harmonics**

Harmonic effects are only described here in terms of an analytical study of a harmonic system. These harmonics influence system losses, operation, and performance, making them ubiquitous in a power system. If they are not contained within acceptable limits, harmonics can damage both power and electronic equipment, resulting in costly system outages.

Harmonic effects are caused by both voltage and current, but the effects of current are more often seen in a conventional performance. However, degradation of insulation can be caused by voltage effects, thereby shortening equipment life. The list below describes some common harmonic effects:

- Losses in equipment, cables, lines, etc.
- Rotating equipment produces pulsating and reduced torque
- Increased stress in equipment insulation causing premature aging

- Rotating and static equipment producing increased audible noise
- Waveform sensitive equipment being misoperated
- Resonances causing significant amplification of voltage and current
- Inductive coupling between power and communication circuits causing communication interference

Common harmonic studies including harmonic flows and filter design tend not to involve an in-depth analysis of harmonic effects when the limits of a standard or user are met, but in some specific cases, a separate study is required for harmonics penetrating into rotating equipment, affecting communication circuits, or causing misoperation of relays.

## **Resonance**

Elements of a power system circuit are predominantly inductive. This means the inclusion of shunt capacitors for power-factor correction or harmonic filtering can cause inductive and capacitive elements to transfer cyclic energy at the natural resonance frequency. Inductive and capacitive reactance is equal at this frequency.

When viewed from a bus of interest, commonly the bus where a nonlinear source injects harmonic currents, the combination of inductive (L) and capacitive (C) elements can result in either a series resonance (L and C in series) or a parallel resonance (L and C in parallel). The following sections will show that a series resonance results in low impedance, while a parallel resonance will result in a high impedance. The net impedance in either series or parallel is resistive. It is essential that the driving-point impedance (as seen from the bus of interest) is examined in a harmonic study, to determine the frequencies of series and parallel resonances, and their resulting impedances.

PF correction capacitors are commonly used in practical electrical systems to offset utility-imposed power factor penalties. The combination of capacitors and inductive elements in the system can result either in series or parallel resonance, or a combination of both, depending on the system configuration, which can result in an abnormal situation. Parallel resonance is more common as capacitor banks act in



parallel with inductive system impedance, which can be a problem when the resonant frequency is close to one of those generated by the harmonic sources.

Series resonance can result in unexpected amounts of harmonic currents flowing through certain elements. Excessive harmonic current flow can cause inadvertent relay operation, burned fuses, or overheating of cables.

Parallel resonance may produce excessive harmonic voltage across network elements. Commonly, this will cause capacitor or insulation failure.

### Series Resonance

Figure 1 shows an example of a series resonant circuit, with each element described in terms of its impedance. Equations (1) and (2) express the equivalent impedance of the circuit and current flow. This circuit is in resonance when  $X_L$  is equal to  $X_C$  (inductive reactance equal to capacitive reactance). Equation (3) gives the resonant frequency at which  $X_L = X_C$ .

$$\bar{Z} = R + j(X_L - X_C) \quad \text{Eq. (1)}$$

$$\bar{I} = \frac{\bar{V}}{R + j(X_L - X_C)} \quad \text{Eq. (2)}$$

$$= \frac{V}{R} \text{ at resonance } (X_L = X_C)$$

$$\omega_0 = \frac{1}{\sqrt{LC}}$$

$$f_0 = \frac{1}{2\pi\sqrt{LC}} \quad \text{Eq. (3)}$$

The magnitude of the current in Equation (2) at resonance can be significant due to the relatively low values of series resistance in power equipment.

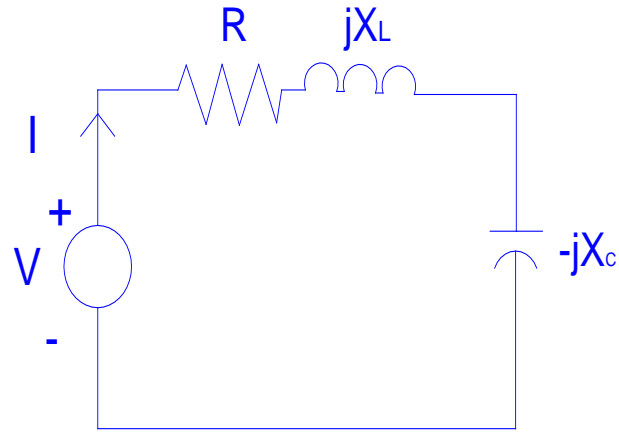

Figure 1. Series resonance circuit example.

Figure 2 indicates equivalent impedance of the Figure 1 circuit as a function of frequency where  $R = 2 \Omega$ ,  $L = 3.98 \text{ mH}$ , and  $C = 36.09 \mu \text{ F}$ . Equation (1) shows that impedance at low frequencies appears capacitive and only becomes inductive as the frequency increases. That resonance occurs at 420 Hz.

The shape of the impedance plot of Figure 2 can be shown in terms of  $Q$ , the quality factor. In a circuit which is series resonant, Equation (4) can define  $Q$  for any given angular frequency  $\omega$ .

$$Q = \frac{\omega L}{R} \quad \text{Eq. (4)}$$

$Q$  at the resonant frequency can be approximated to the ratio of  $\frac{\omega_0 L}{R_L}$  as there is negligible resistance in capacitors since  $R \approx R_L$ . This element  $Q$  is often important in filter design, as most single-tuned harmonic filters are simple RLC series-resonant circuits. A higher  $Q$  generally creates a more obvious “dip” in the plot of Figure 2, while lower  $Q$  values will result in a rounded shape. Most filter applications have a high natural quality factor of over one hundred at resonant frequency when no intentional resistance is involved. It can be necessary to deliberately reduce the value of  $Q$  in some specific applications.

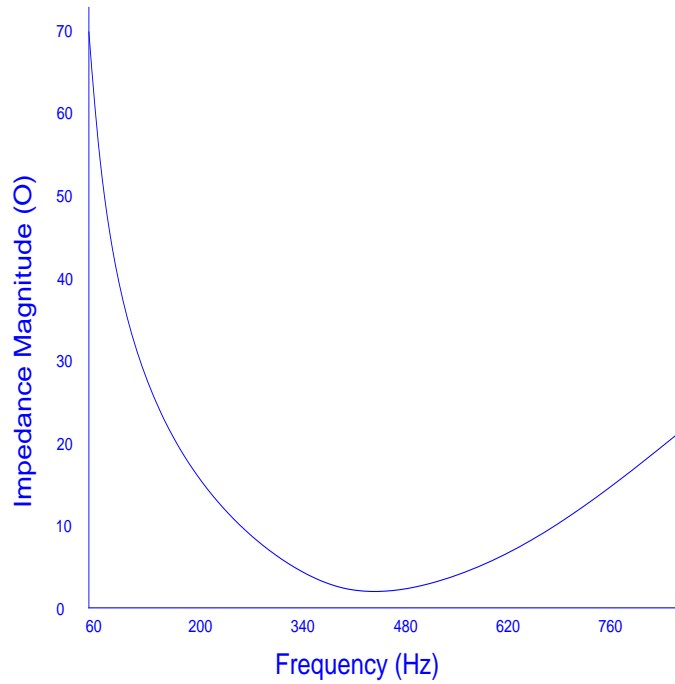

Figure 2. Impedance magnitude vs. frequency in a series resonant circuit

Series resonance is commonly a problem in the situations shown in the one-line diagrams of Figure 3. The utility supply in this figure is presumed to encompass voltage harmonics. The equivalent series impedance of the utility supply, the bus transformer, and the power factor correction capacitor create a series resonant path.

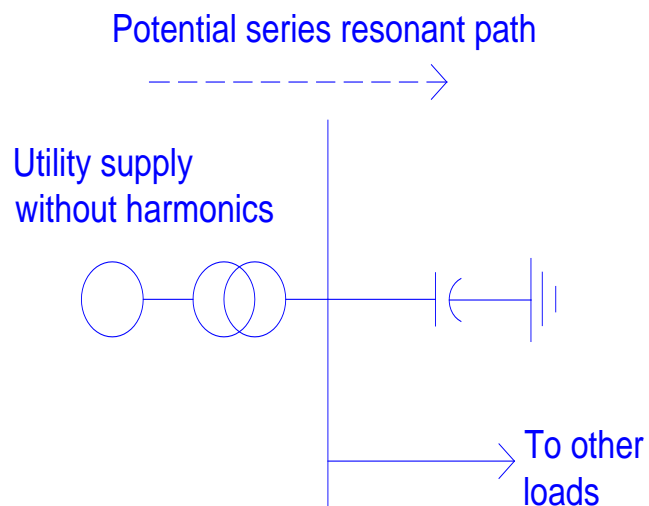

Figure 3. Utility source including harmonics

In Figure 4, the plant generates the harmonics internally. The series resonant path includes both of the transformer impedances, along with the PF correction capacitor.

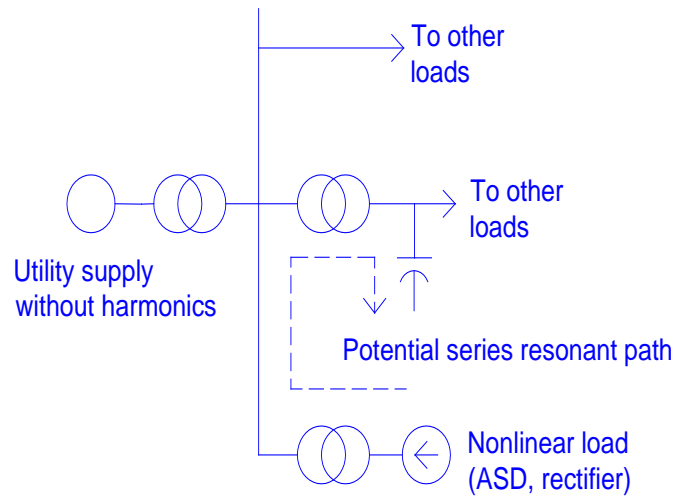

Figure 4. Plant harmonics

Harmonic current flow can be permitted at or near resonant frequency into the capacitor bank if the transformer-capacitor combination inadvertently acts as a filter. When unplanned, this can result in blown fuses, inadvertent relay operation, or loss of life in the transformer or capacitor.

### Parallel Resonance

Parallel resonant circuits exist in various different forms. An inductor usually needs to be in parallel with a capacitor to be able to produce parallel resonance. An example of a common parallel-resonant circuit can be found in Figure 5, where each element is defined by its impedance. As with series resonance, this circuit is in parallel resonance when  $X_L = X_C$ .

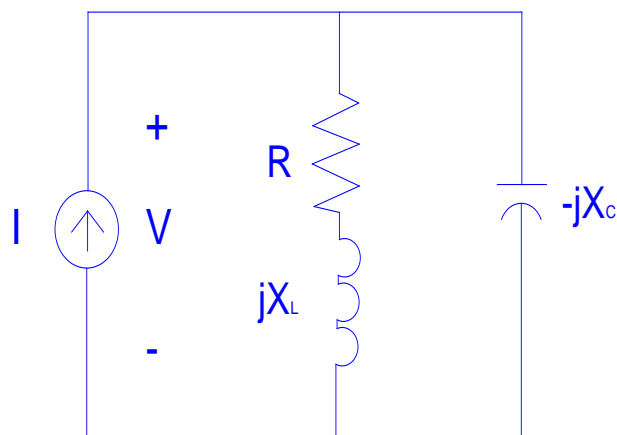

Figure 5. Common parallel resonant circuit

Equation (5) defines the equivalent impedance the current source in Figure 5 can see.  $X_L = X_C$  and the denominator is reduced to  $R$  when at the resonant frequency given by Equation (3).

$$\bar{Z} = \frac{-jX_C(R+jX_L)}{R+j(X_L-X_C)} \quad \text{Eq.(5)}$$

Equation (6) gives the voltage across the complete circuit.

$$\bar{V} = \bar{I}\bar{Z} \quad \text{Eq.(6)}$$

The resistance of power circuits is fairly small in most cases. Equation (5) shows that resonances can produce significant equivalent impedances around the resonant frequency, as generally  $R$  is quite small. A plot of the magnitude of impedance in Equation (5) is shown in Figure 6, using the previously assigned values of  $R = 2 \Omega$ ,  $L = 3.98 \text{ mH}$ , and  $C = 36.09 \mu\text{F}$ . More conveniently, the sharpness of Figure 6 can be calculated via the “current gain factor (rho,  $\rho$ )” as the ratio of current in the capacitive or inductive branch to the injected current.

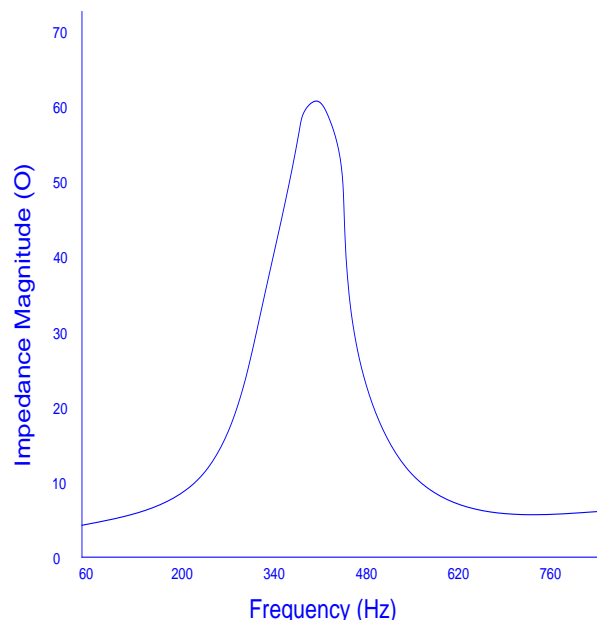

Figure 6. Impedance magnitude vs. frequency for parallel circuits

When a parallel resonant circuit is excited by a current source at this frequency, a

high circulating current will flow in the capacitance-inductance loop, regardless of the source current being comparatively small. This is unique to a parallel resonant circuit. Loop circuit current is amplified dependant purely on the quality factor  $Q$  in the circuit.

Typically, parallel resonance involves the following:

- Equivalent inductance of a utility system and/or large transformer leakage inductance
- Power factor correction capacitors; e.g. the one-line for parallel resonance in Figure 7

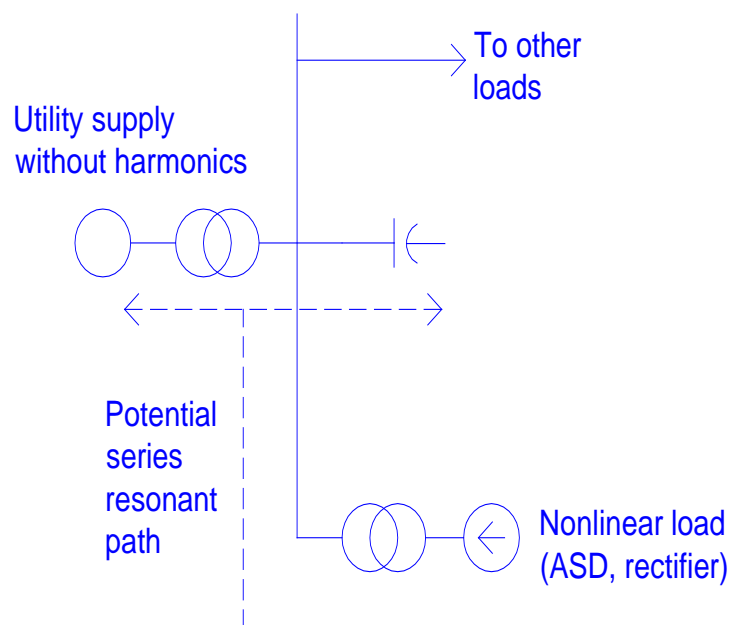

Figure 7. Possible parallel resonant circuit: Plant harmonics

### Resonances Caused by Multiple Filters

Figure 8 shows a driving-point impedance plot, as seen from a bus on which three tuned filters (5, 7 & 11), a load, and the system impedance representing the utility are connected in parallel. This illustrates multiple resonances being present.

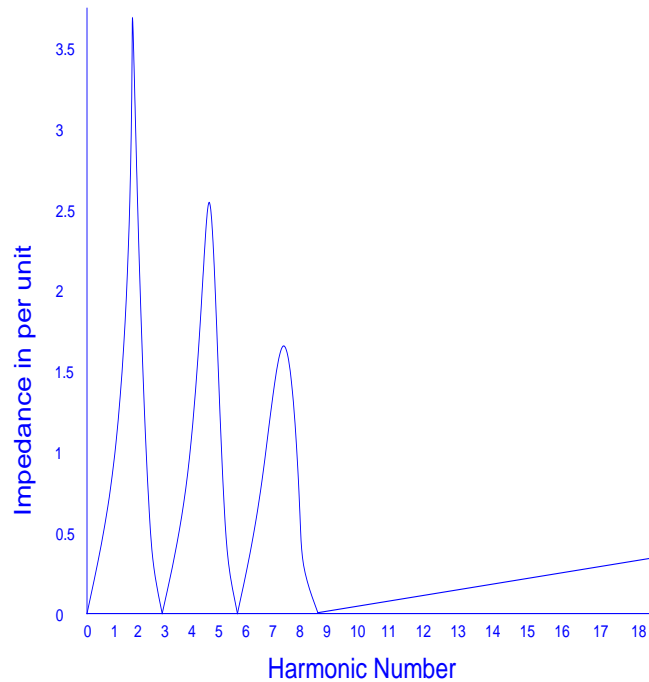

Figure 8. Impedance characteristic of multiple tuned filters

As you can see, there are as many parallel resonance points as filters in the system. Near the third harmonic you will find the first parallel resonant frequency, caused by system and load impedance. The second is due to the inductive part of the first filter (4.9) in conjunction with the capacitive part of the second filter (7<sup>th</sup> harmonic), and the third occurs between the 7<sup>th</sup> and 11<sup>th</sup>. When filters are tuned at odd harmonics (5, 7 & 11), parallel resonances will more commonly occur in between, frequently around halfway, depending on filter sizes.

### System Modelling

When a large number of non-linear loads, usually more than 25-30% of the total system or bus load, occur in a system or are expected to be added in the future, a harmonic analysis is required. PF correction capacitor banks are often added without considering resonances, therefore a study may be necessary to take corrective action. Power system component failure is also a situation that can commonly generate the need for harmonic studies. Any of the following techniques can be used to study the system response to harmonics:

- *Hand Calculations.* Manual calculations can be used, however these are quite tedious and vulnerable to error, and are therefore restricted to small networks
- *Transient Network Analyzer or TNA.* These are also kept to smaller networks, as they are usually time consuming and expensive.
- *Field Measurements.* Often, harmonic measurements can be used to establish individual and total harmonic distortions in a system. This can be done as part of design verification, standard compliance, or field problem diagnosis. These are effective for validating and refining system modelling in digital simulations, especially if a parallel resonance is encountered, or non-characteristic harmonics are present. If using field data for digital simulations of harmonic current injections, particular attention should be paid if the data differs significantly from generally acceptable values per unit, or calculated values. Interharmonic measurements also require special instrumentation and consideration.

It can be expensive and time-consuming to take harmonic measurements systematically. They only consider the circumstances in which they were taken, therefore can't be guaranteed to reflect the worst possible conditions of a system. Measurements can also be inaccurate due to measuring errors or flawed use of instruments.

- *Digital Simulation.* The most convenient and perhaps economical system analysis method, as computer technology affords quite advanced programs with a variety of system component models that can be used in various different cases. Powerful, elegant numerical calculation techniques work with the ideas of system impedance and admittance matrices to perform a system-wide analysis

While they do require additional information for frequency dependence, short-circuit and load-flow data can be used for harmonic studies. The behaviour of the equipment involved must be predicted for frequencies above and beyond the current or usual values. The subclause below provides a summary of system modelling for



harmonic analysis. Assume the models and constants are just examples, as many others can be substituted.

### Generator Model

Modern generator designs do not produce any substantial harmonic voltages, and are therefore not considered harmonic sources. They can instead be represented by a grounded impedance, often using a reactance derived from subtransient or negative sequence reactances. As compared with subtransient impedance values, negative sequence impedances for small units tend to agree within 15%. A simple series RL circuit representing the subtransient reactance with an  $X/R$  ratio ranging between 15 and 50 at fundamental frequency can be used if there is no better available model, or until more results are reported. Generator resistance at high frequencies needs to be corrected due to skin effect, by suggested use of the following equation.

$$R = R_{DC}(1 + Ah^B) \quad \text{Ed. (7)}$$

Where  $R_{DC}$  represents the armature dc resistance and  $h$  the harmonic order. Coefficients  $A$  and  $B$  have typical respective values of 0.1 and 1.5.

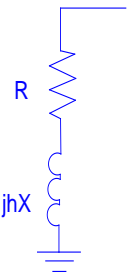
System Components	Equivalent Circuit Model	Model Parameters
Synchronous Machines		$R = R_{DC}(1 + Ah^B)$ $X = X'' \text{ or } X_2 = \frac{X_d'' + X_q''}{2}$

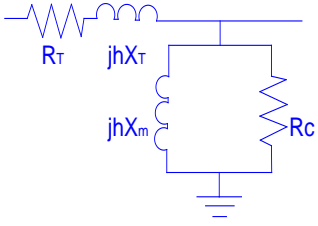
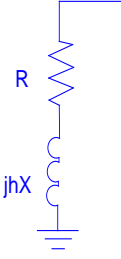
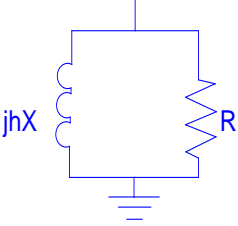
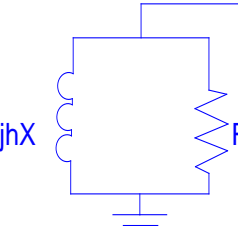
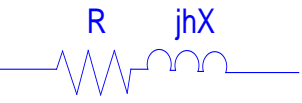
<p>Transformer</p>	 <p>Ignored if not a significant harmonic source</p>	$R_T = R_{DC}(1 + Ah^B)$ <p><math>R_T</math> and <math>X_T</math> are transformer rated R and X values</p>
<p>Induction Machines</p>		$R = R_{DC}(1 + Ah^B)$ $X = X'' \text{ or } X_2 = \frac{X_d'' + X_q''}{2}$
<p>Load</p>	<p>Static Load</p>  <p>Motor Load</p> 	$R = \frac{V^2}{P} \quad X = \frac{V^2}{Q}$  $R = \frac{V^2}{P} \quad X = \frac{V^2}{Q}$
<p>Line and Cable</p>	<p>Short line and cable</p> 	$M = 0.001585 \sqrt{\frac{f}{R_{DC}}}$ <p><math>f</math> – frequency (Hz)</p> <p><math>R_{DC}</math> – dc resistance <math>\left(\frac{\Omega}{m}\right)</math></p>

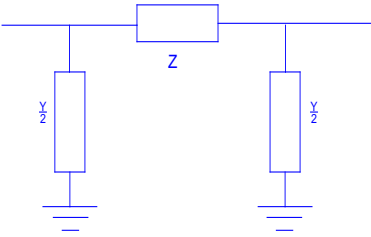
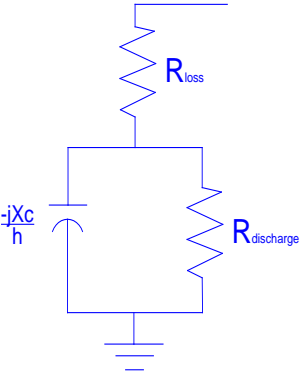
	<p>Long line (equivalent Pi)</p> 	<p><math>l</math> – length in meters</p> $R = R_{DC}(0.035M^2 + 0.938), M < 2.4$ $R = R_{DC}(0.035M^2 + 0.3), M \geq 2.4$ $z = r + jx_L \left( \frac{\Omega}{m} \right)$ $y = g + jb_c \left( \frac{S}{m} \right)$ $Z_c = \sqrt{\frac{z}{y}} \quad \gamma_e = \sqrt{zy}$ $Z = Z_c \sinh(\gamma_e l)$ $\frac{Y}{2} = \frac{1}{Z_c} \tanh\left(\frac{\gamma_e l}{2}\right)$
<p>Shunt Capacitor</p>		

## Transformer Model

When in series with the nominal leakage impedance, a transformer can be modelled as an ideal transformer. Leakage reactance has a linear variance with frequency, but skin effect must be accounted for in proper resistance modelling. A similar expression with similar coefficient values  $A$  and  $B$  to that used for generator resistance can be used. In more complex models, it is suggested to account for magnetizing reactance, core loss, interturn and interwinding transformer capacitances. At relatively high frequencies, transformer resonance starts to occur well above the 50<sup>th</sup> harmonic, so capacitances are generally ignored. Core losses and the magnetizing branch are also usually neglected.

## Induction Motor Model

In harmonic analysis, the standard induction motor circuit model, consisting of a stator impedance, magnetization branch with core loss resistance, and a slip-dependent rotor impedance, remains valid. The stator, magnetization branch resistances, and inductances are generally considered independent of frequency, but considerations are given to rotor impedance variations for skin effect, and the definition of an appropriate harmonic slip at non-fundamental frequencies. Skin effect is important for machines with deep bar rotors or double squirrel cages to assess rotor impedance. The frequency of rotor current is high at locked rotor, where slip =1. Skin effect causes high rotor resistance and increased starting torque in rotor constructions, except at the nominal load where current frequency is low and the skin effect is negligible. When rotor resistance reduces substantially, more efficient operation is allowed. This is similar for rotor inductance, though the variation magnitude is much less distinct. This variation in rotor resistance and inductance as a function of slips is usually modelled with linear equations when a part of harmonic analysis. Proportionality coefficients linking rotor resistance and inductance to the slip are known as cage factors, and the relevant expressions are as follows:

$$R_r(h) = \frac{R_{r0}}{S_h} \times (1 + CR \times S_h) \quad \text{Eq. (8)}$$

$$L_r(h) = L_{r0} \times (1 + CX \times S_h) \quad \text{Eq. (9)}$$

where,

$R_r(h), L_r(h)$  are frequency dependent rotor resistance and inductance, respectively,

$R_{r0}, L_{r0}$  represent DC rotor resistance and inductance, respectively,

CR, CX are the rotor cage factors for rotor resistance and inductance, respectively (typical values are  $CR \approx 2$  and  $CX \approx -0.01$ ), and

$S_h$  is the slip at the harmonic frequency.

In situations where motor operation forces rotor currents to span a wide frequency range, this model is used as in harmonic analysis.

Each element of the harmonic current ( $1h$ ) flowing into a motor will see any impedance whose value is defined as per the equations above, at the appropriate slip. For that slip value ( $S_h$ ) the first expression of the value is obtained from the basic slip definition, where the slip is the difference between the stator or harmonic frequency and the rotor electrical frequency, divided by the stator frequency.

$$S_h = \frac{\omega_h - \omega_r}{\omega_h} = \frac{h \times \omega_0 - (1-s) \times \omega_0}{h \times \omega_0} = \frac{h+s-1}{h} \cong \frac{h-1}{h} \quad \text{Eq. (10)}$$

where,

$h$  is the harmonic order,

$\omega_h, \omega_r, \omega_0$  are the harmonic angular frequency, rotor angular frequency, and synchronous frequency, respectively, and

$S$  is the conventional slip at fundamental frequency.

At higher harmonic orders, we notice that harmonic slip approaches 1, while resistance and inductance become constants. The harmonic slip can be considered 1 for any harmonic order greater than 9 when used in practice.

Balanced harmonic currents of order  $Nk + 1$ ,  $Nk + 2$ , and  $Nk + 3$  ( $k = 0, 1, 2$  for  $N = 1, 2, 3 \dots$ ) have been associated with the positive, negative, and zero sequences, respectively. A negative sequence flux will rotate opposite to the rotor direction, and the rotor flux frequency can be defined as the sum of the rotor and stator frequencies. By replacing the minus sign in the harmonic slip expression, we can take this into account, as shown below.

$$S_h \cong \frac{h \pm 1}{h} \quad \text{Eq. (11)}$$

where,

“−” is applied to positive sequence harmonics,

“+” is applied to negative sequence harmonics, and

$S_h = 1$  for zero sequence harmonics.

At higher frequencies, the magnitude of the harmonic slip approaches unity, and we can approximate the motor inductance using its locked rotor or subtransient value.

## **Load Model**

There have been various models proposed to denote individual and aggregate loads in harmonic study. There are specific models available for any individual load, regardless of whether they are passive, rotating, solid-state, or otherwise. Aggregate loads are usually represented as a parallel or series combination of inductances and resistances. These are produced as estimated values based on the load power at fundamental frequency. Using this model we can show aggregates of passive or motor loads. Resistance and inductances are considered constant over the range of involved frequencies in this model.

## **Transmission Line and Cable Models**

A series RL circuit denoting the line series resistance and reactance can be used to represent a short line or cable, but the resistance needs to be corrected for skin effect at higher frequencies. Modelling the line shunt capacitance becomes necessary with longer lines. Lumped parameter models like the equivalent pi model, or distributed parameter models can both be used for this task. The latter is generally more representative of the line response when used over a wide range of frequencies. Cascading several lumped parameter models will approximate the distributed line model. In either model, it is worthwhile to cascade sections to represent a long line, as this produces a better profile of harmonic voltage along the line.

The following expression can be used to evaluate the variation in line resistance caused by skin effect:

$$R = R_{dc}(0.35X^2 + 0.938), X < 2.4 \quad \text{Eq. (12)}$$

$$R = R_{dc}(0.35X + 0.3), X \geq 2.4 \quad \text{Eq. (13)}$$

where,

$$X = 0.001585 \left( \frac{f}{R_{dc}} \right)^{0.5},$$

$f$  is frequency in Hz, and

$R_{dc}$  is in  $\Omega/\text{mi}$ .

## Filter Models

By definition, a filter will exhibit small impedances at tuned frequencies. When tuned to the fundamental frequency, they supply reactive power to the electrical network as their impedance is capacitive. In power systems, different types of filters are used to serve various different needs. The most common filters for harmonic mitigation can be seen in Figure 9, as well as their individual characteristics.

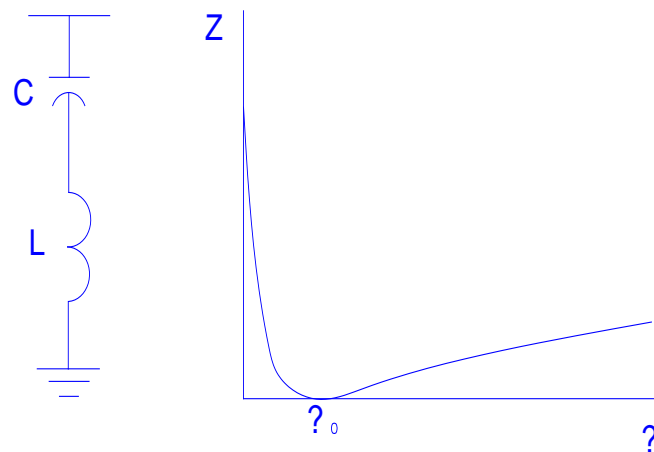

Single tuned filter

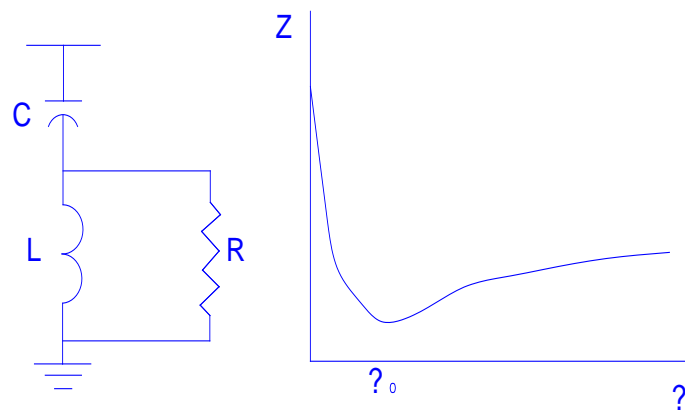

High-pass filter (second order)

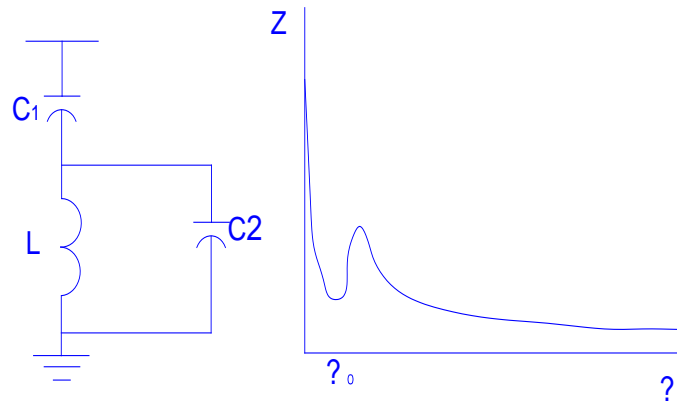

Undamped high-pass filter (third order)

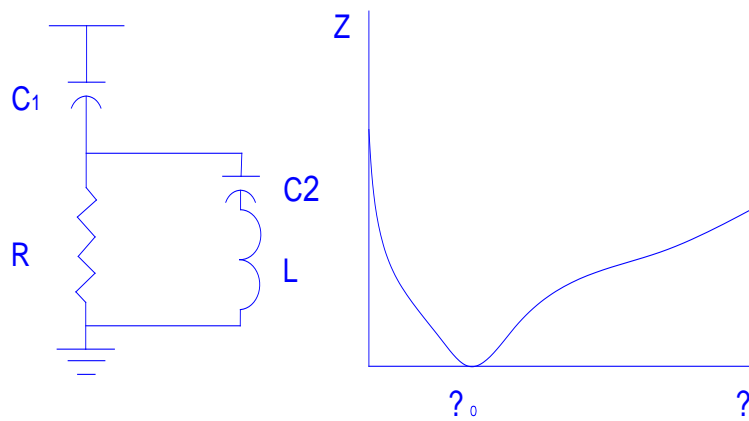

High-pass C-type filter (third order)

Figure 9. Filters commonly used for harmonic mitigation

Single-tuned filters can be used to suppress specific harmonics around the tuned frequency. High-pass filters can be of first, second and third orders. The second is commonly used to suppress high frequencies, and a recent “C-type” filter is becoming popular as it features smaller losses at the fundamental frequency.

Filter application is often used as a solution in limiting harmonic effects. Other measures include moving disturbing loads to a higher voltage level, reinforcing a system, changing the size of capacitors, and adding tuning reactors to a capacitor bank. Economics will always determine the most appropriate solution for a situation. Recently, studies have advocated active filtering to counter injected harmonics near the source, but this is mostly applicable in low-voltage systems.



## Network Modelling and Computer-Based Solution Techniques

The most common methodology of harmonic analysis, although several others have also been used successfully, is the current injection method. This models nonlinear loads as ideal harmonic sources, and represents each network element with a set of linear equations corresponding to its previously described circuit. Ohm's law and Kirchoff's laws connect all network elements and loads according to the network topology. Mathematically, this means each bus of the network holds an equation. So at bus  $i$ , connected to a set of buses  $j$ , we have the following:

$$[\sum_j Y_{ij}] \times V_i = I_i + \sum_j (Y_{ij} \times V_j) \quad \text{Eq. (14)}$$

By solving this system of equations, we obtain the nodal voltages. This computation is performed for each harmonic frequency of interest. From the harmonic voltages we can compute the harmonic currents in each branch:

$$I_{ij} = (V_i - V_j) \times Y_{ij} \quad \text{Eq. (15)}$$

Most of the work involved comes from forming the network equations. There are excellent linear equation solvers available.

The inverse of the nodal admittance matrix is known as the nodal impedance matrix, and is full of quantitative information. The diagonal entry on the  $i^{\text{th}}$  row is known as the Thevenin impedance of the network, as seen by bus  $i$ . We can obtain the frequency response of a network from each bus by computing these matrix values over a range of frequencies. This computation can be used to obtain exact resonant frequencies. In this matrix, off-diagonal values show the effect on bus voltages of a harmonic current injection.

The total harmonic distortion, rms value, telephone interference factor, and related factors  $VT$  and  $IT$  are computed from the harmonic voltage or current ( $U_n$ ) and the fundamental frequency ( $U_1$ ) quantities as below.

$$\text{Total harmonic distortion (THD)} = 100 \frac{\sqrt{\sum_{n=2}^{\infty} V_n^2}}{V_1} \quad \text{Eq. (16)}$$

where  $n$  is the harmonic order and usually the summation is made up to the 25<sup>th</sup> or 50<sup>th</sup> harmonic order.

$$\text{rms value: } U_{rms} = \sqrt{\sum_{n=1}^{\infty} V_n^2} \quad \text{Eq. (17)}$$

$$\text{VT or IT: } UT = \sqrt{\sum_{f=0}^{\infty} (K_f \times P_f \times V_f)^2} \quad \text{Eq. (18)}$$

where  $U$  designates either voltage or current.

$$\text{Telephone interference factor: } TIF = \frac{\sqrt{\sum_{f=0}^{\infty} (K_f \times P_f \times V_f)^2}}{V} \quad \text{Eq. (19)}$$

where  $V$  is the voltage and  $K_f$  and  $P_f$  are the weighting factors related to hearing sensitivity. These quantities are useful in summarizing a harmonic analysis into quality-related factors.

Two impedance calculations are made in a harmonic analysis to study system characteristics in both series and parallel resonances. These are the driving point and transfer impedances. Driving point impedance is defined by voltage at a node  $i$  due to current injected at the same node, otherwise use:

$$Z_{ii} = \frac{V_i}{I_i} \quad \text{Eq. (20)}$$

As this is the net impedance of circuits from that bus, useful information on resonances can be acquired. Changing the locations of capacitors, cables etc. in a circuit, or the design of planned filters, can change the driving point impedance and therefore the resonance etc. Transfer impedance is similar to driving point impedance in the sense that it is the voltage measured at a bus due to injected current at another bus; in other words:

$$Z_{ij} = \frac{V_i}{I_j} \quad \text{Eq. (21)}$$

where,

$Z_{ij}$  is the transfer impedance to bus  $i$ ,

$V_i$  is the voltage measured at bus  $i$ ,

$I_j$  is the current injected at bus  $j$ .

This is useful when evaluating harmonic voltages at any bus other than the one where the current is injected.

## Harmonic Analysis for Industrial and Commercial Systems

The following list summarizes the steps a harmonic study consists of in the industrial environment:

- Prepare a system one-line diagram. Be sure to include capacitor banks, long lines and cables within the industrial or utility system near the point of common coupling (PCC).
- Collect data and ratings for equipment.
- Obtain nonlinear load locations and generated harmonic currents.
- From the utility company, collect the necessary data and harmonic requirements at the PCC. These should include the following:
  - o System impedances, or minimum and maximum fault levels, as a function of frequency for various system conditions.
  - o Acceptable harmonic limits, including distortion factors and IT factor. Criteria and limits vary considerably around the world.
- Carry out harmonic analysis for the base system configuration, through calculation of the driving point impedance loci at harmonic source buses, and all shunt capacitor locations.
- Compute individual and total harmonic voltage, current distortion factors, and IT values if applicable, at the point of common coupling.
- Examine the results, and return to the first or third step, depending whether the network data or parameters of the analysis need to be changed.

- Compare the composite (fundamental plus harmonic) shunt capacitor bank loading requirements with the maximum rating permitted by the applicable standards.
- Relocate the capacitors or change the bank ratings if they exceed the necessary ratings. If a resonance condition is found, apply a detuning reactor. (Note that adding a tuning reactor will increase the fundamental voltage on the capacitor and may also increase harmonic voltage.)
- If the harmonic distortion factors and IT values at the PCC exceed the limit imposed by the utility, add more filters.

These steps should be followed both for the base system configuration and any system topologies resulting from likely contingencies. System expansions and short-circuit level changes in the future should also be taken into consideration in the process.

### **Data for Analysis**

For a typical study, the following data is required:

- A single-line diagram of the power system in question.
- The short-circuit capacity and X/R ratio of the utility power supply system, and the existing harmonic voltage spectrum at the PCC (external to the system being modeled).
- Subtransient reactance and kVA of any rotating machines. If limitations exist, one composite equivalent machine can be formed from all the machines on a given bus.
- Reactance and resistance of cables, lines, bus work, current limiting reactors, and the rated voltage of the circuit the element belongs to. These units can be presented in per-unit or percent values, or ohmic values, depending on preference or software usage.
- The three-phase connections, percent impedance, and kVA of all power transformers.
- The three-phase connections, kvar, and unit kV ratings of all shunt and reactors.

- Nameplate ratings, number of phases, pulses, and converter connections, whether they are diodes or thyristors, and, if thyristors, the maximum phase delay angle per unit loading, and loading cycle of each converter unit involved in the system. Manufacturer's test sheets for each converter transformer are helpful but not mandatory. If this information is not readily available, the kVA rating of the converter transformer can be used to establish the harmonic current spectrum being injected into the system.
- Specific system configurations.
- Maximum expected voltage for the nonlinear load system.
- In the case of arc furnace installations, secondary lead impedance from the transformer to the electrodes, plus a loading cycle to include arc megawatts, secondary voltages, secondary current furnace transformer taps, and transformer connections.
- Utility-imposed harmonic limits at the PCC, otherwise limits specified in applicable standards may be used.

## **Example Solutions**

In this section, several applications of harmonic studies will be discussed. Frequency scans, capacitor effects, and filter design will be established.

## **Test System Single-Line Diagram and Data**

Figure 10 will be used for all examples, as the system in this diagram is representative of a common industrial power system, including power factor correction capacitors and voltage levels. Tables 1, 2 and 3 include the necessary data for a basic harmonic study.

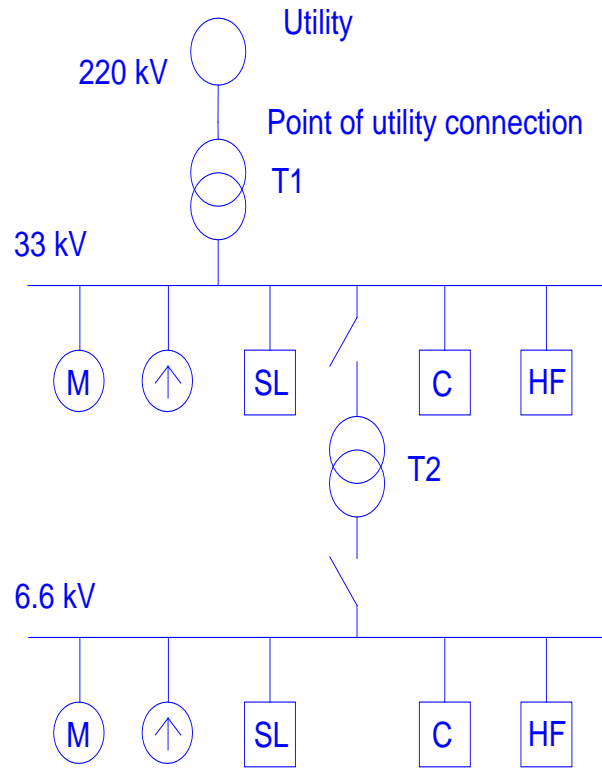

Figure 10. Example system for harmonic studies

Parameter	Value
Supply voltage	220 kV
Short-circuit capacity	4000–10 000 MVA
X/R	20.0

Table 1. Utility supply data

Parameter	T1	T2
Power rating (MVA)	100	30
Voltage rating (kV)	220–33	33–6.6
Impedance (%)	14	10
X/R	10.0	10.0

Table 2. Transformer data

Load	Type	Value
33 kV bus	Linear load	25 MVA @ 0.8 lag
	Converter	25 MW
	Capacitor	8.4 Mvar
6.6 kV bus	Linear load	15 MVA @ 0.8 lag
	Converter	15 MW
	Capacitor	5 Mvar

Table 3. Load and capacitor data

These capacitor banks have been designed to output a power factor of 0.95, lagging at the low-voltage side of each transformer. They may consist of both series and parallel units. The modelling of harmonic studies is, in most cases, not entirely different from static load. Table 3 therefore includes both types for each bus.

### Case Study 1: Diode Rectifier on 33 kV Bus

The impact caused by a proposed adjustable-speed motor drive installed at the 33 kV bus need to be determined. The switches connecting the 33-6.6 kV transformer are open for the purpose of this study, so the 6.6 kV bus is ignored for this purpose. The harmonic source is a standard diode rectifier supplying 25 MW on the DC side, depicted in Figure 10 as a current source. At the 33 kV bus, a frequency scan is performed. Figure 11 shows the resultant driving point impedance. Note the resonant point as shown by a distinct peak in the impedance near the 8<sup>th</sup> harmonic (480 Hz).

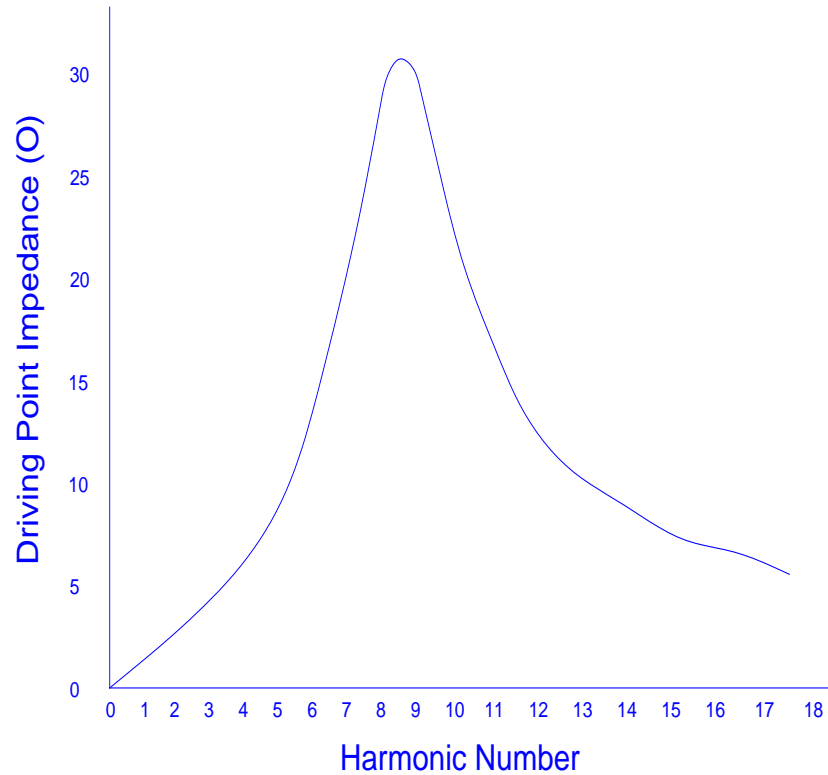

Figure 11. Driving point impedance at 33 kV bus

The impact caused by the resonant condition can be found from multiple solutions, one at each frequency of interest, of the nodal equation set for the system. Table 4 shows the harmonic content of the diode rectifier current on the ac side, while Figures 12, 13, 14 and 15 show the voltage waveforms and harmonic magnitude spectra at the 33 kV and 220 kV buses, including approximate voltage THDs. These are computed waveforms.

Harmonic number	Frequency (Hz)	Magnitude (A)	Phase (degrees)
1	60	618	0
5	300	124	180
7	420	88	0
11	660	56	180
13	780	47	0
17	1020	36	180
19	1140	33	0

Table 4. Harmonic content of diode rectifier current on ac side



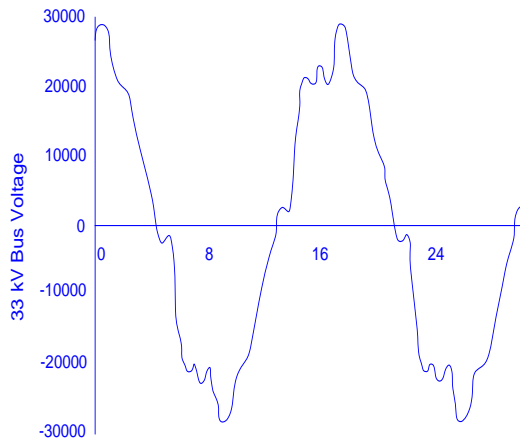

Figure 12. Voltage waveform

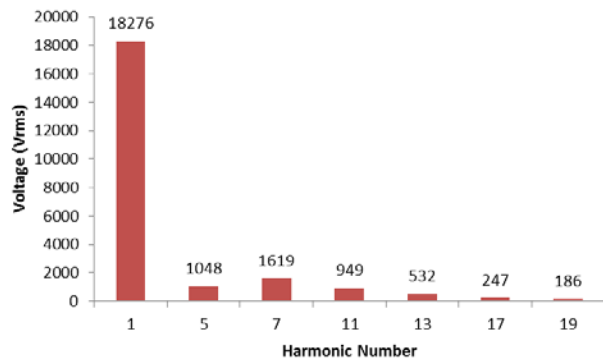

Figure 13. Harmonic number

Line-to-neutral voltage waveform at 33 kV bus

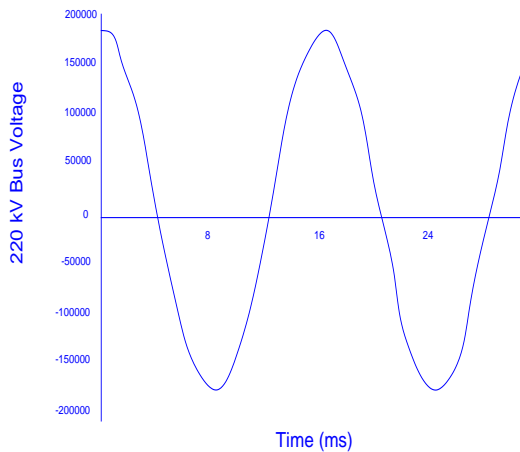

Figure 14. Voltage waveform

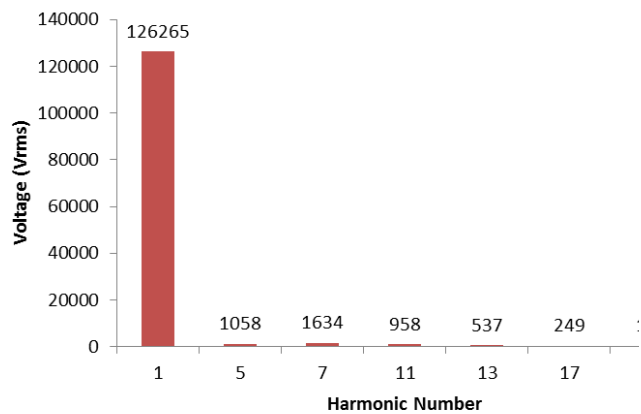

Figure 15. Harmonic number

Line-to-neutral voltage waveform at 220 kV bus

### Case Study 2: Effects of Including the 6.6 kV Bus

This study is almost identical to the above, with the exception of the switches to the 33-6.6 kV transformer being closed, resulting in a connection being formed between the 6.6 kV bus and the system. A frequency scan is now conducted at the 33 kV bus, and Figure 16 shows the resulting driving point impedance. Note that there are two points of resonance. This is expected as typically there will be an equal number of resonance points and capacitors.

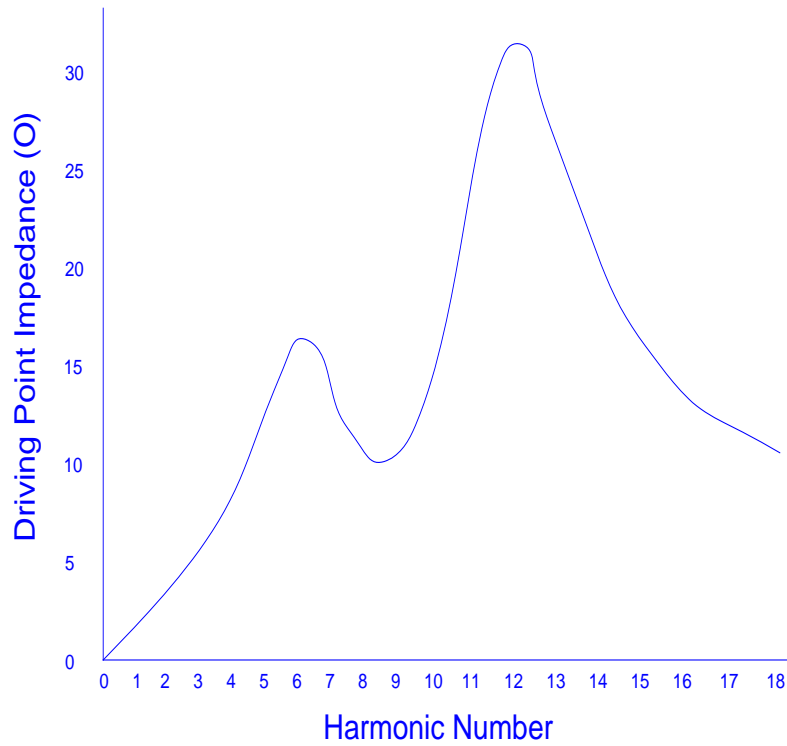

Figure 16. Driving point impedance at 33 kV bus

Table 5 shows the impacts of the resonance points on voltage waveforms. Values are given for the harmonic content and approximate voltage THD at the 6.6, 33 and 220 kV buses.

Harmonic number	Frequency (Hz)	220 kV bus	33 kV bus	6.6 kV bus
1	60	126 090	18 108	3559
5	300	1 125	1 114	329
7	420	606	600	278
11	660	945	936	166
13	780	818	810	85
17	1020	303	300	15
19	1140	216	214	8
	THD (%)	= 1.448	= 9.989	= 13.188

Table 5. Harmonic content of bus voltages including the effects of the 6.6 kV bus

### Case Study 3: Motor Drive on the 6.6 kV Bus

We are to determine the impacts of a proposed motor drive at the 6.6 kV bus, with the 33-6.6 kV transformer switches closed to provide us with a connection to the voltage supply. A diode rectifier delivering 15 MW on the DC side, with the same harmonic current given previously for the rectifier, represents the aforementioned drive.

Figure 17 gives the results of a frequency scan performed at the 6.6 kV bus, and displays multiple resonant frequencies near the 6<sup>th</sup> and 12<sup>th</sup> harmonics (360 and 720 Hz respectively). Table 6 displays the impacts of the resonance points on voltage waveforms.

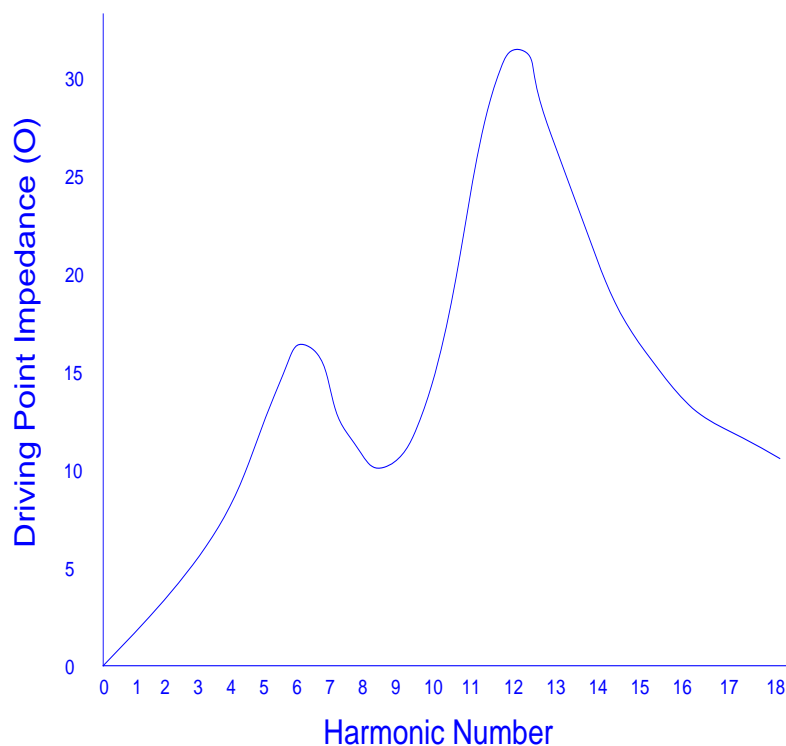

Figure 17. Driving point impedance at 6.6 kV bus7

Harmonic number	Frequency (Hz)	220 kV bus	33 kV bus	6.6 kV bus
1	60	126 296	18 307	3 476
5	300	956	947	461
7	420	807	799	294
11	660	482	477	101
13	780	248	246	100
17	1020	45	45	47
19	1140	25	24	35
	THD (%)	= 1.081	= 7.383	= 16.339

Table 6. Harmonic content of bus voltages: Motor drive at 6.6 kV bus

#### Case Study 4: Evaluation of Harmonic Limits

Assuming nonlinear loads at the 33 kV and 6.6 kV buses are both operating, this case study performs an analysis of the supply voltage and current. This type of study demonstrates compliance with imposed harmonics limits, and is useful to demonstrate that a facility is meeting standards set by a serving utility company. In Figures 18 and 19 you can see the input current and voltage waveforms at the PCC where we must meet harmonic limits.

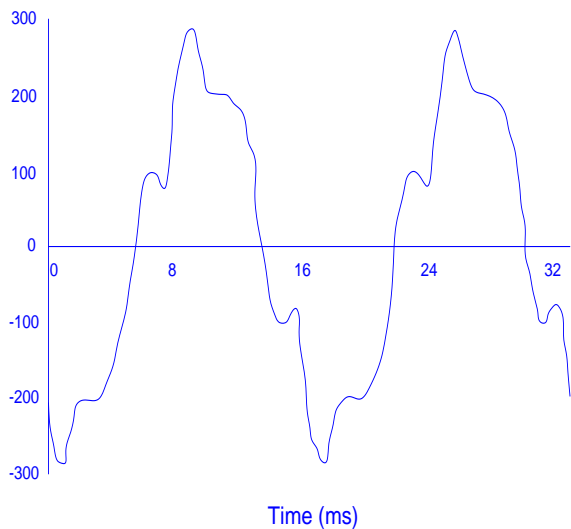

Figure 18. Line-to-neutral voltage at PCC

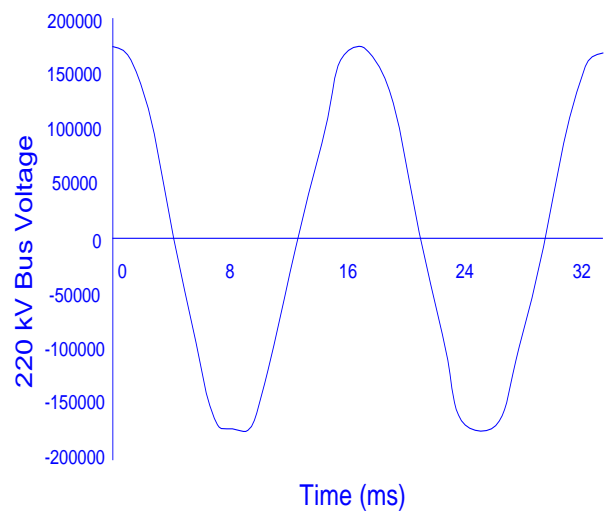

Figure 19. Line-to-neutral voltage at PCC

Table 7 displays the frequency contents of the waveforms, including the approximated THD values. For the purpose of evaluating compliance standards, an average maximum demand is assumed of 80 MVA (typically over a one year period). This figure expresses existing harmonics as a percentage of the maximum demand current.

Harmonic number	Actual harmonic current magnitudes (percent of average maximum demand current)	Limits for harmonic current magnitudes (percent of average maximum demand current)	Actual harmonic voltage magnitudes (kVLN, rms)	Limits for harmonic voltage magnitudes (percent of fundamental)
1	N/A	N/A	125.8	N/A
5	15.0	3.0	1.9	1.0
7	5.8	3.0	1.03	1.0
11	1.7	1.5	0.48	1.0
13	1.8	1.5	0.60	1.0
17	0.6	1.15	0.27	1.0
19	0.4	1.15	0.20	1.0
	THD = 16.3%	TDD = 3.75%	THD = 1.85%	THD = 1.5%

Table 7. Harmonic limit evaluation at PCC

The recommended limits in Table 7 clearly show that there are violations of harmonic limits in play. The concept of total demand distortion or TDD in line currents is used in place of the THD so as to account for percentages in regard to average maximum demand as opposed to the fundamental component. Voltage harmonics are expressed as percentages of the fundamental component, and use THD. Significant voltage distortion is present inside the plant at the 33 kV and 6.6 kV buses, despite the PCC being near compliance. Note that different countries have different limits for their harmonics at various points in the system.

## Representation of the Utility System

Considering the effects of variations in the utility supply fault MVA on the frequency response of the industrial system is important, and requires disconnecting the 33-6.6 kV transformer (thereby including the entire 6.6 kV bus). In Figure 20 you can see a portion of the frequency scan results for the system in our example. When the utility fault MVA is varied from a minimum of 4000 MVA to a maximum of 10,000 MVA, with the system  $X/R$  held constant at 20.0 (and 60 Hz), we retrieve a plot that shows a general increase in resonant frequency as the utility fault MVA increases. This concludes that industrial systems with strong utility supplies or high fault MVAs are less likely to have issues with resonance conditions when at low frequencies.

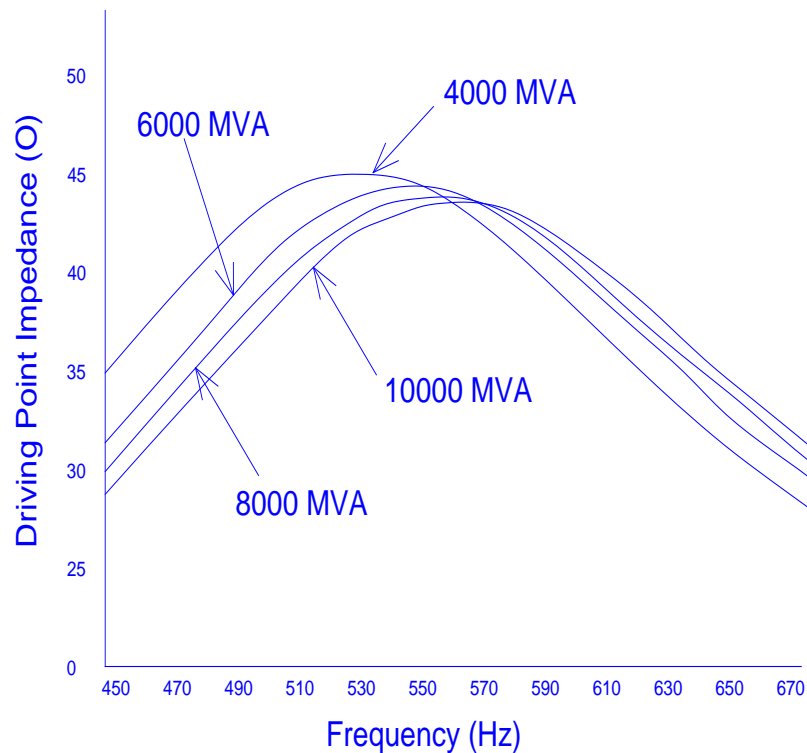

Figure 20. Variations in frequency response at 33 kV bus as a function of capacitor bank size

## Effects of Size of Power Factor Correction Capacitors

In most systems, power factor correction capacitors are applied to help lower operation costs. Due to the size of power factor capacitors, it becomes important to

consider variations in frequency response. For this study, the 33-6.6 kV transformer and the 6.6 kV bus are again disconnected. The utility fault MVA is constant at 4000 MVA, and  $X/R$  at 20.0 (60 Hz). Figure 21 demonstrates driving point impedance changes at the 33 kV bus as a function of capacitor bank size.

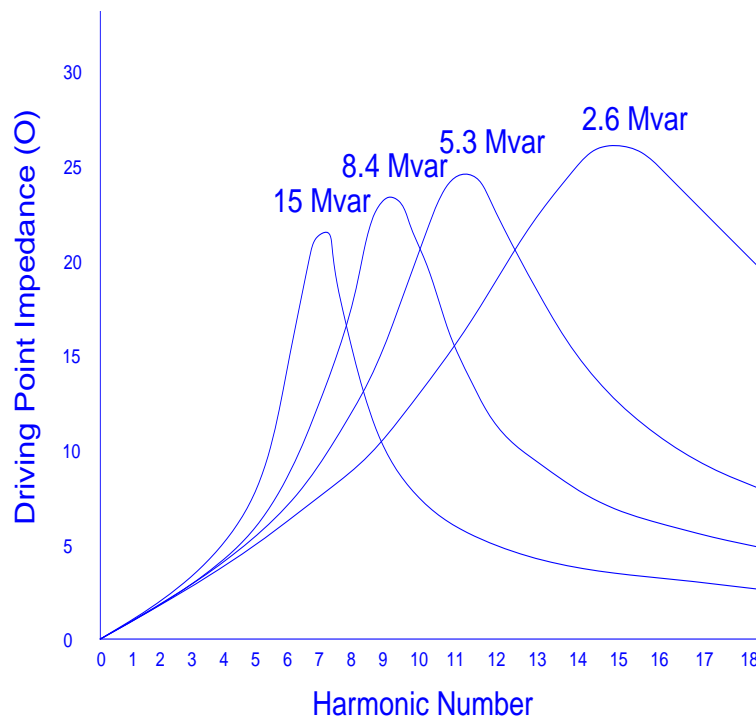

Figure 21. Variations in frequency response at 33 kV bus as a function of capacitor bank size

As shown in these plots, the resonant frequency decreases as the power factor and capacitor bank size increase. Also, peak resonant impedance increases as capacitor bank size and power factor decrease. The tendency of resistive damping to increase along with frequency can lessen the effect of resonant impedance increasing.

### Single-Tuned filter Application

In Figure 12 you can see a distortion of the waveform for the study conditions of Case Study 1. This can be eliminated by use of an RLC filter (or multiple) tuned to provide a low impedance path to ground at the frequencies of interest. An example of the effect of filter application would be a filter created using a tuning reactor in series with the power factor correction capacitor bank in Case Study 1. Figure 12

shows us via frequency scan results that the resonant point is near 480 Hz or the 8<sup>th</sup> harmonic. The filter can be tuned to remove this resonance, however this more than likely would produce a lower frequency resonance that coincides more with the rectifier harmonics. Filter tuning frequencies should therefore be selected by removing specific harmonic currents before they can excite resonant modes, instead of selecting a tuning frequency to modify a specific frequency response. It is important to apply a filter at the lowest current harmonic frequency, in this case 300 Hz or the 5<sup>th</sup> harmonic as mentioned above, as the application of single-tuned filters tends to produce a new resonant point at a lower frequency. Ideally, a filter should be tuned to this low frequency (i.e. 300 Hz) but often significant variations in system parameters are enough to shift the resonant frequency in Figure 20 slightly. To counter this, single-tuned filters can be, and often are, constructed based around a target frequency 3-5% lower than that of the harmonic current to be removed.

Most applications use a single-tuned filter created from the existing power factor correction capacitors. At power frequencies of 50-60 Hz, the series RLC combination supplies reactive power to the system as it appears to be capacitive. The series impedance at the tuned frequency is very low, and provides a low impedance path to ground for the specific harmonic currents needed.

In Case Study 1, we have an 8.4 Mvar capacitor bank size at 33 kV. The appropriate tuning reactor can be found using standard formulae and a per-phase approach. A 5.87  $\Omega$  reactor with  $X/R = 14.3$  at 60 Hz is selected, and the filter is tuned to 282 Hz, or the “4.7<sup>th</sup>” harmonic. Figure 22 shows the frequency response of this single-tuned filter using the specified values for resistance, inductance and capacitance. Notice that there is a very low impedance just below 300 Hz or the 5<sup>th</sup> harmonic.

At the 33 kV bus with the filter in place, the driving point and voltage waveform can be found in Figures 23 and 24. The voltage waveform THD is reduced, from 12.23% in Case Study 1, to 6.32%. Another single-tuned filter near the 7<sup>th</sup> harmonic would be necessary at the 33 kV bus to meet stringent voltage distortion limits at this location. In many applications, multiple filters of this type, tuned to frequencies near the load-generated harmonic currents, are used in conjunction with a high-pass filter to satisfy realistic voltage distortion limits.



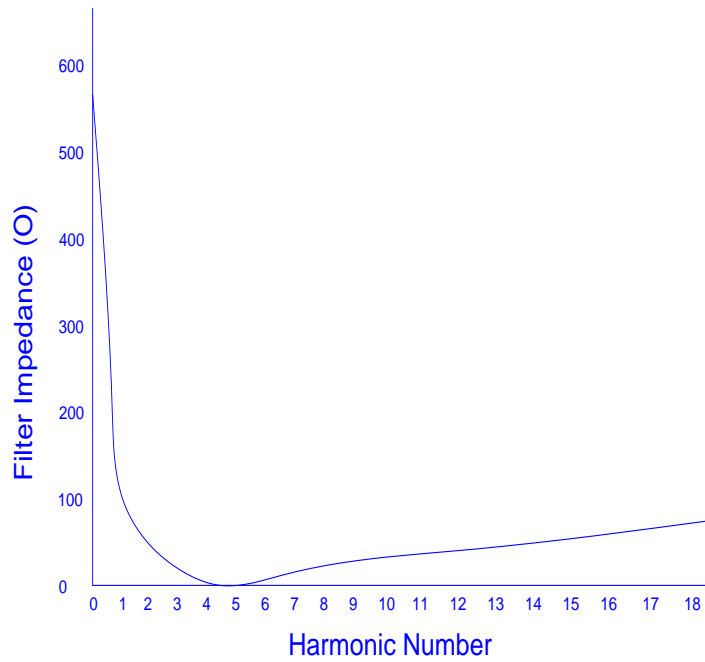

Figure 22. Frequency response of single-tuned filter

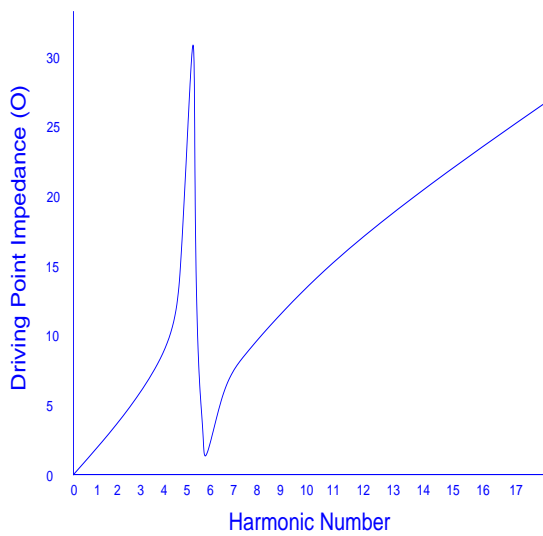

Figure 23. Driving point impedance

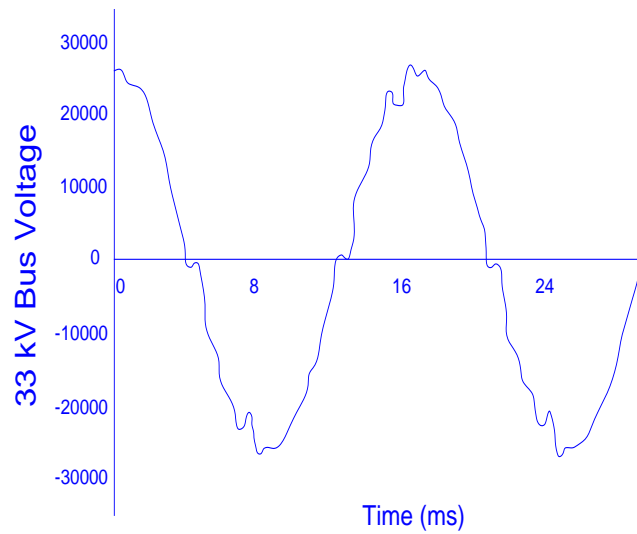

Figure 24. Figure Line-to-neutral voltage

33 kV bus impedance and voltage characteristic with a single-tuned filter

## Remedial Measures

There are multiple ways to remedy the harmonic problem in a system, and the following will discuss, in general, the types of solutions available. An exact solution

will depend on multiple factors, including whether the system is new or previously existing, is flexible to changes, is open to adding harmonic filters, or is receptive to modification of existing capacitor banks.

- Care should be taken when designing or expanding a system to ensure that the total harmonic load is kept to a low percentage of the total plant load, with around 30% being a good maximum target. Consideration should be given to the location of harmonic loads, number of buses, size of transformers, choice of connections, etc. in addition to adding harmonic filters, if the measured or calculated levels of distortion are quite high.
- As per Figure 25, harmonic loads can be separated so that sensitive loads are not influenced by high harmonic loads. All heavy loads, in the order of several MVA, should have a dedicated transformer. For example, large drives or arc furnaces in a steel mill should have these. If several similar loads exist, their transformers could be connected in delta and wye alternately to cancel out some specific characteristic harmonics. Secondary buses connected with tie breakers require caution to ensure sensitive loads are not energized at the same time as harmonic sources.

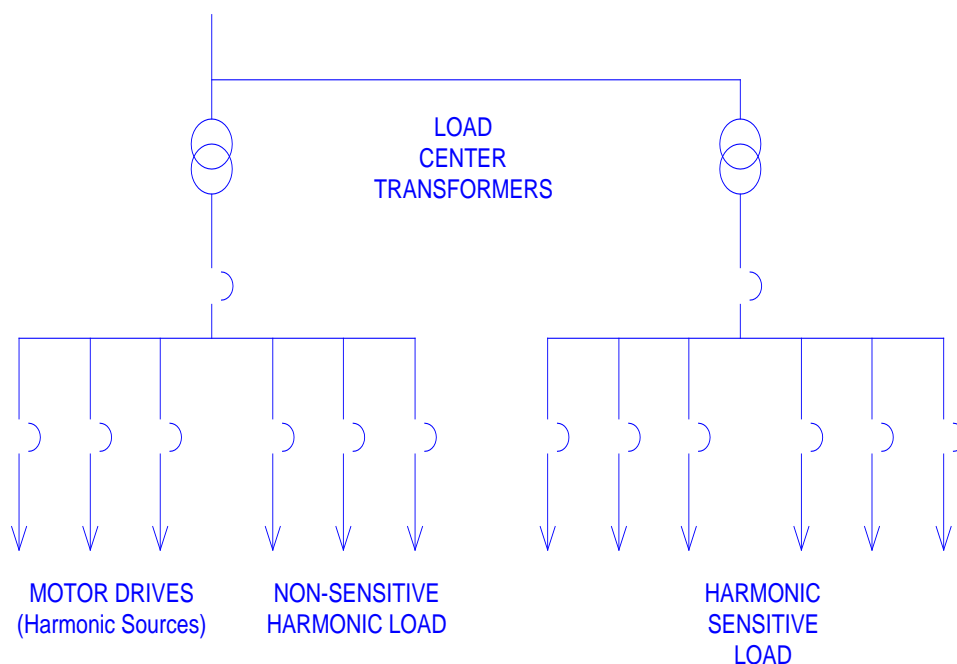

Figure 25. Separation of harmonic loads

- One very effective method of reducing harmonics is “multipulsing”. This is not always a viable option due to the high transformer cost. In some industries, rectifiers are connected with 6-pulse converters to form a 12, 24 or higher pulse system. In Table 8 you can see the phase shift needed between bridges to form a multiple system. Bear in mind that a residual harmonic may still be present as the cancellation between bridges is not complete.

Pulse number	6	12	18	24	30	36	42	48
Number of units	1	2	3	4	5	6	7	8
Phase shift in degrees	0	30	20	15	12	10	8.57	7.5
Lowest harmonic order	5	11	17	23	29	35	41	47

Table 8. Transformer phase shift for various multipulse system

- The most common measure for correcting harmonic mitigation is the use of harmonic filters tuned to the appropriate frequencies. Existing capacitor banks can be modified to tuned filters using tuned reactors, provided the capacitors are rated acceptably, or new filter banks can be added to the system.

## Filter Selection

Filter selection is more of an art than it is a science. There is no single correct solution to any given situation. Usually, there are a number of solutions available and the system designer must choose one to best suit the specifications of the project, and make compromises to fit discretion and limitations. Industrial systems commonly use multiple single-tuned filters, but there may be other types of filters available. This discussion is limited to a procedure rather than the pros and cons of individual filters.

Usually, harmonic study begins with a preliminary filter design based on previous experience. This is further refined as the harmonic performance indices are deciphered. This refinement process involves several steps to determine the appropriate number of filters, effective reactive power compensation, and performance indices. Other considerations include filter switching and protection, loss of filter banks, and space requirements. An obvious solution is to use as few

filters as possible, and compare this performance with no filter. Filter location is something else to take into consideration. Effective filtering generally necessitates that the filters be located at higher voltage levels, near the PCC or main bus, to meet the demands of all harmonic sources.

Filters are most commonly tuned to one of the odd dominant characteristic harmonics, starting from the lowest order. Generally this will be 5, 7, 11, etc. In some cases the lowest order can be 2 or 3, as in arc furnace applications. Ideally filters should be tuned to the exact harmonic order needed, but practical considerations mean it may be necessary to tune below the nominal frequency. If the parallel resonance frequency needs to be offset, the filter may intentionally be tuned above or below the nominal frequency. For example, if a 5<sup>th</sup> harmonic filter causes resonance near the 3<sup>rd</sup>, tuning it slightly below or above the 5<sup>th</sup> can offset the resonance at the 3<sup>rd</sup>. Another example is where the resonant frequency is very close to the 5<sup>th</sup>, e.g. 4.7 for very sharp filters, it will be desirable to tune it below to avoid the resonant frequency coinciding with the harmonic injection frequency when accounting for tolerances, temperature deviations, etc.

Capacitors and reactors, the two main parts of a passive filter, are discussed here. The nominal fundamental kvar rating of capacitors determines the harmonic filtering effectivity. An initial estimate of the capacitor kvar is therefore very important. A larger bank size makes it easier to meet a given harmonic performance criteria. Beside the harmonic requirements, you may need to consider the following design factors:

- The system power factor or displacement power factor may be corrected to a required or more desirable value, usually above 0.9.
- If a transformer is overloaded, the total kVA demand on the supply transformer may have to be reduced.
- The current ratings of buses and cables may also have to be reduced.

Generally, a capacitor needs to be derated to be able to absorb additional duty from harmonics. A derating factor of 15-20% in voltage is desirable. Because of this derating, the kvar will be reduced by the square of the factor. However, loss of kvars

is somewhat compensated for by the cancellation of capacitive reactance in the filters inductive reactance. The effect of this is to increase the voltage of a capacitor (above bus voltage) by the factor below.

$$c = \frac{h^2}{h^2-1} \quad \text{Eq. (22)}$$

For a conventional single-tuned filter this factor is calculated in Table 9.

Harmonic order	3rd	5th	7th	11th	13th
Per-unit voltage	1.125	1.049	1.021	1.008	1.005

Table 9. Fundamental voltage across a single-tuned filter capacitor

When the harmonic study is finished, and the filter selection is complete, a capacitor rating with respect to voltage, current and kvar should be checked. These three elements need to be individually satisfied. The filter designer can do this himself if standard units are used, or the capacitor supplier can be requested to meet them if special units are used.

In industrial applications, an air or iron core reactor can be used, depending on size and cost. In general, iron-core reactors are limited to 13.8 kV, while air-core reactors can cover the complete range of low, medium, and high voltage applications. Iron-core reactors can save space and can be enclosed in housing either indoors or outdoors, along with capacitors and other components as needed.

Reactors need to be rated for the maximum fundamental current along with the worst generated harmonics for the “worst” system configuration. The reactor vendor must calculate all losses, fundamental and harmonic, core in the case of iron-core reactors, and stray due to frequency effects. This is to ensure hot-spot temperatures are within acceptable limits for dielectric temperature.

A big unknown in the filter design is the Q factor, or the ratio of inductive resistance to that of the tuned frequency. This can generally be estimated based on prior

experience, but if it is determined during the study that  $Q$  is not critical, the reactor should be specified to have the “natural  $Q$ ”, or that of the reactor that is naturally obtained with no cost or design consideration. However, if a low- $Q$  reactor will help mitigate amplifications near parallel resonance, then a low- $Q$  reactor should be specified. Manufacturers have a high tolerance of up to 20% that should be recognized in  $Q$  values. Bear in mind that a low- $Q$  design will produce higher losses.