

VINNITSA NATIONAL AGRARIAN UNIVERSITY

Department of Electric Power Engineering, Electrical Engineering and Electromechanics



CALCULATION OF TRANSIENT PROCESSES USING THE DUHAMEL INTEGRAL

by Associate Professor V. Hraniak



BASIC CONCEPTS

If the voltages and currents in the circuit do not change their values over time, then they are called direct current (DC) and marked by the letters U and I.

Voltages and currents that change in magnitude and (or) direction are called alternating current (AC), are characterized by instantaneous values, that is, their values at any moment in time, and are marked by the letters $u(t)$ and $i(t)$.

For a periodic alternating current, the condition is fulfilled

$$i(t) = i(t+T).$$

The cycle of current changes is repeated after a time interval T , which is called a period. The inverse of the period, i.e. the number of current periods per second is called the frequency

$$f = \frac{1}{T}$$

and is measured in Hertz [Hz]. The standard frequency in the energy systems of Ukraine is 50 Hz.

SINUSOIDAL CURRENT

Sinusoidal current is described by the equation

$$i(t) = I_m \sin\left(\frac{2\pi}{T}t + \alpha\right)$$

where $i(t)$ - the instantaneous value of the current, that is, the value of the current at any moment in time;

I_m - amplitude or maximum value;

$\left(\frac{2\pi}{T}t + \alpha\right)$ - oscillation phase;

$\frac{2\pi}{T} = \omega$ - angular (cyclic) frequency, which determines the rate of phase change, is measured in radians per second [rad/s];

α - phase value at $t=0$ (initial phase)

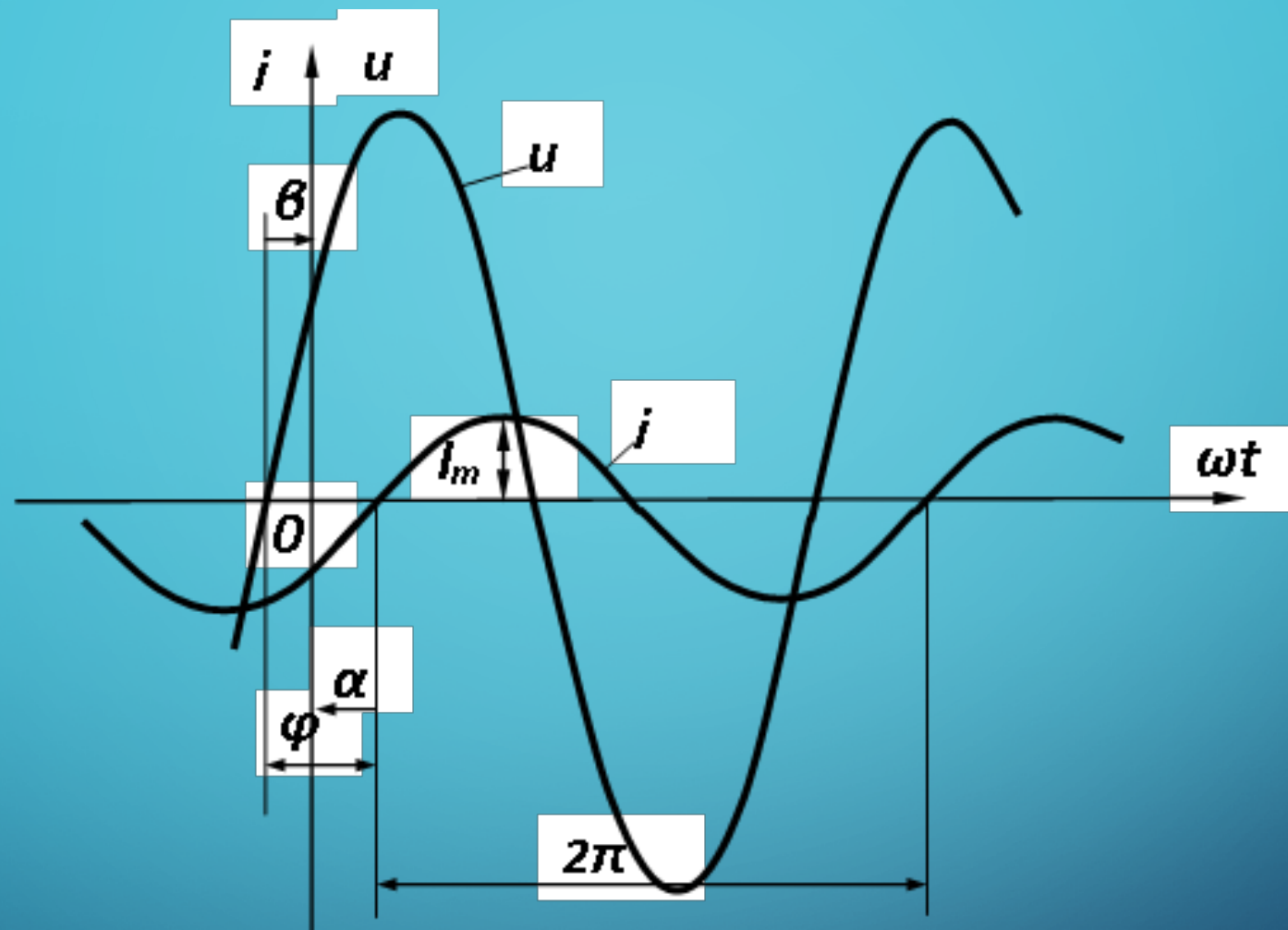

Typical graphs of sinusoidal current and voltage

The initial phase is usually counted from the beginning of the sinusoid

$$\beta > 0 \quad \alpha < 0$$

PHASE SHIFT

If the voltage and current have different initial phases, then they are said to be out of phase by an angle

$$\varphi = \beta - \alpha$$

which is called the phase shift angle.

If $\varphi > 0$ the voltage is ahead of the current or the current lags behind the voltage in phase.

If the initial phases of two sinusoids are the same, $\beta = \alpha$ the voltage and current are said to be in phase.

That is, $\beta - \alpha = \pm\pi$ if the sinusoids are shifted in phase by half the period, then these sinusoids are said to be in antiphase.

EXAMPLE

Calculate the cyclic frequency, the amplitude and the initial phase of the alternating current:

$$i(t) = 5 \cdot \sin(314t + 30^\circ)$$

$$I_m = 5(A) \quad \omega = 314(\text{rad} / \text{s}) \quad \alpha = 30^\circ$$

Calculate the cyclic frequency and amplitude of the alternating voltage:

$$u(t) = 300 \cdot \cos(314t - 45^\circ)$$

$$u(t) = 300 \cdot \cos(314t - 45^\circ) = 300 \cdot \sin(314t - 45^\circ + 90^\circ)$$

$$U_m = 300(V) \quad \omega = 314(\text{rad} / \text{s}) \quad \beta = 45^\circ$$

Calculate the phase shift between voltage and current:

$$\phi = \beta - \alpha = 45 - 30 = 15^\circ$$

RMS (ROOT MEAN SQUARE) CURRENT AND RMS (ROOT MEAN SQUARE) VOLTAGE

Average value of current is referred as RMS Current & average value of voltage is referred as RMS Voltage

The notation rms stands for root-mean-square, which means the square root of the mean (average) value

$$I_{rms} = \sqrt{(i^2)_{avg}}$$

$$i^2 = \frac{1}{2} I_{max}^2$$

$$I_{rms} = \frac{I_{max}}{\sqrt{2}} = 0.707 I_{max}$$

$$P_{avg} = I_{rms}^2 R$$

$$V_{rms} = \frac{V_{max}}{\sqrt{2}} = 0.707 V_{max}$$

INDUCTORS IN AN AC CIRCUIT

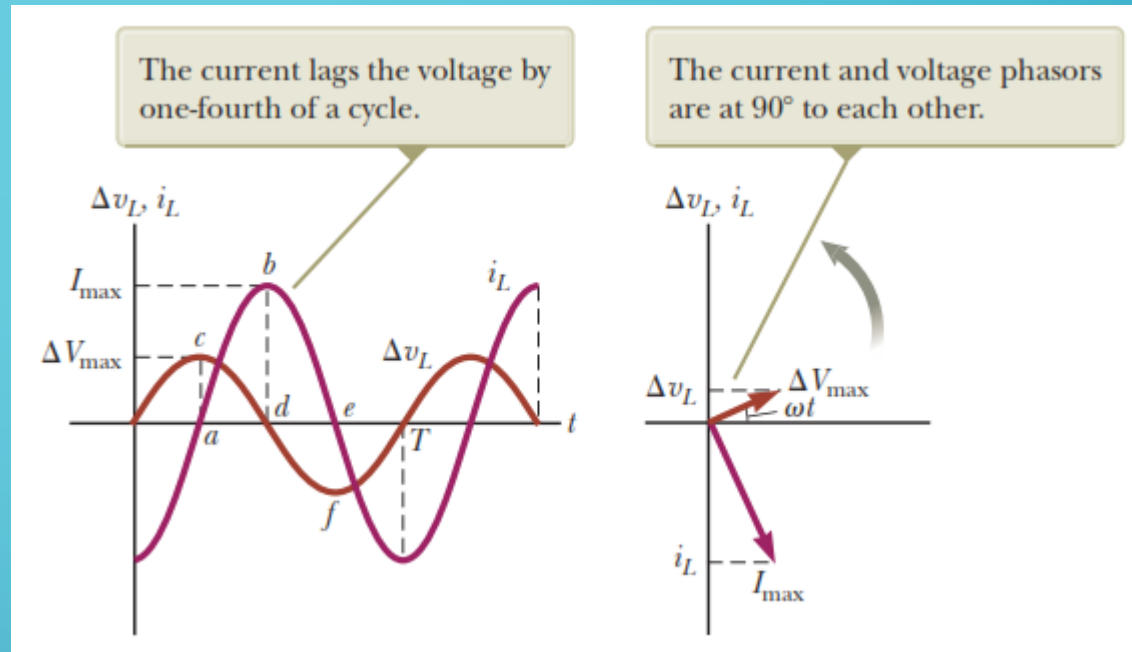
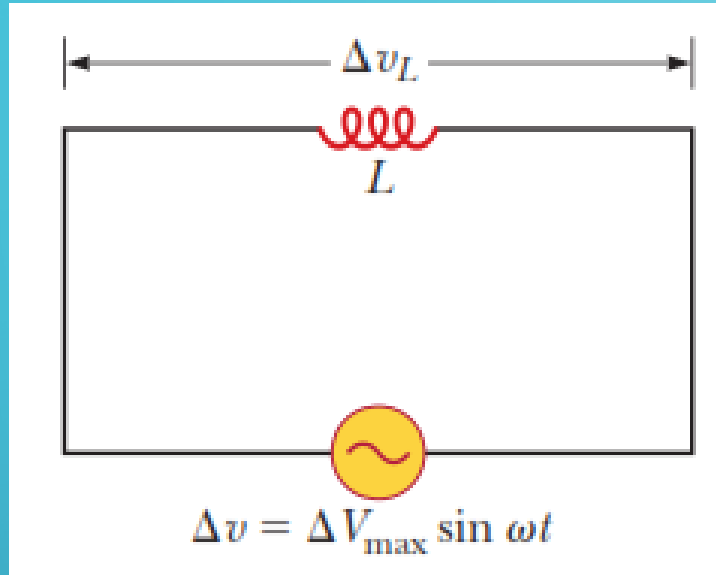

Instantaneous current and voltage are out of phase by $\pi/2$

$$\Delta v + \Delta v_L = 0$$

$$\Delta v - L \frac{di_L}{dt} = 0$$

$$\Delta v = L \frac{di_L}{dt} = \Delta V_{\max} \sin \omega t$$

$$di_L = \frac{\Delta V_{\max}}{L} \sin \omega t dt$$

$$i_L = \frac{\Delta V_{\max}}{L} \int \sin \omega t dt = -\frac{\Delta V_{\max}}{\omega t} \cos \omega t$$

$$i_L = \frac{\Delta V_{\max}}{\omega t} \sin(\omega t - \frac{\pi}{2})$$

$$I_{\max} = \frac{\Delta V_{\max}}{\omega L}$$

ωL is defined as inductive reactance X_L

$$X_L = \omega L$$

CAPACITORS IN AN AC CIRCUIT

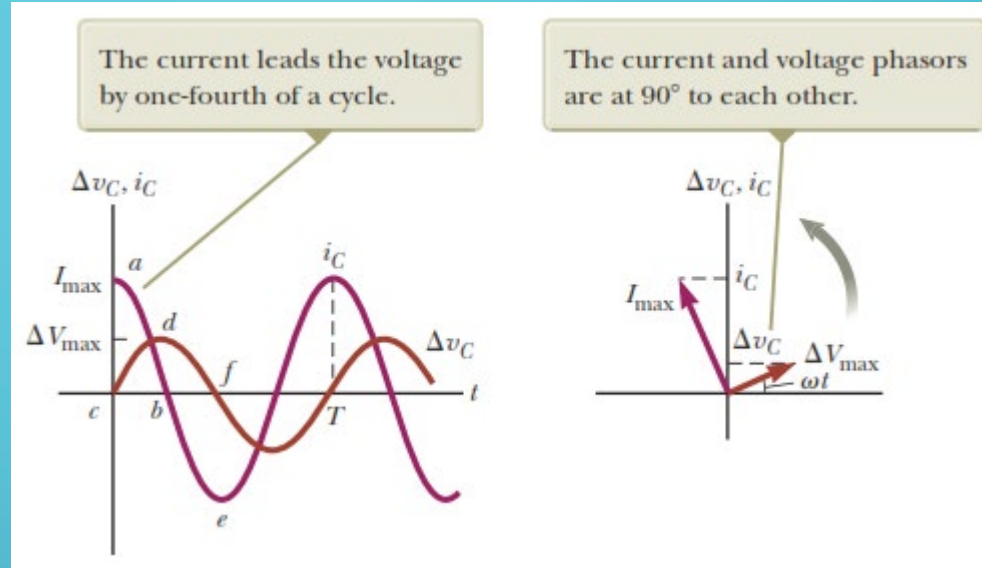
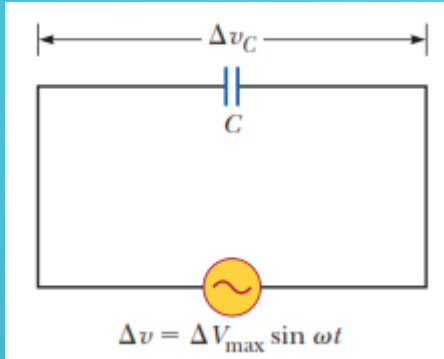

$$\Delta v + \Delta v_C = 0$$

$$\Delta v - \frac{q}{C} = 0$$

$$q = C \Delta V_{\max} \sin \omega t$$

$$i_c = \frac{dq}{dt} = \omega C \Delta V_{\max} \cos \omega t$$

$$i_c = \omega C \Delta V_{\max} \sin\left(\omega t + \frac{\pi}{2}\right)$$

Instantaneous current and voltage are out of phase by $\pi/2$

$$I_{\max} = \omega C \Delta V_{\max} = \frac{\Delta V_{\max}}{(1/\omega C)}$$

$(1/\omega C)$ is defined as capacitive reactance X_C

$$X_C = 1 / \omega C$$

THE RLC SERIES CIRCUIT

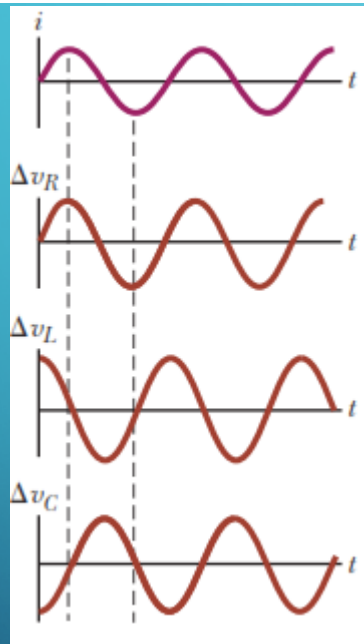
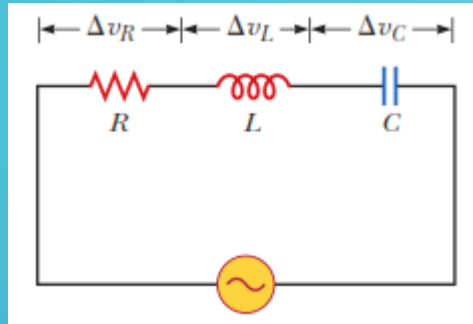

$$\Delta v_R = I_{\max} R \sin \omega t = \Delta V_R \sin \omega t$$

$$\Delta v_L = I_{\max} X_L \sin\left(\omega t + \frac{\pi}{2}\right) = \Delta V_L \cos \omega t$$



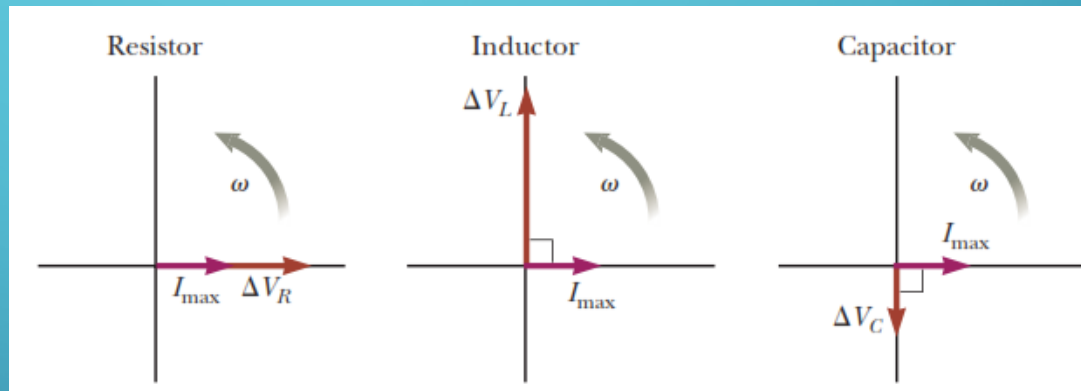

$$\Delta v_C = I_{\max} X_C \sin\left(\omega t - \frac{\pi}{2}\right) = -\Delta V_C \cos \omega t$$

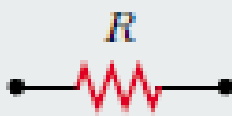

Impedance

$$Z \equiv \sqrt{R^2 + (X_L - X_C)^2}$$

Impedance Values and Phase Angles for Various Circuit-Element Combinations^a

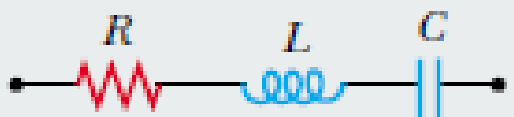
Circuit Elements	Impedance Z	Phase Angle ϕ
	R	0°
	X_C	-90°
	X_L	$+90^\circ$
	$\sqrt{R^2 + X_C^2}$	Negative, between -90° and 0°
	$\sqrt{R^2 + X_L^2}$	Positive, between 0° and 90°
	$\sqrt{R^2 + (X_L - X_C)^2}$	Negative if $X_C > X_L$ Positive if $X_C < X_L$

ACTIVE POWER IN AN AC CIRCUIT

No power losses are associated with pure capacitors and pure inductors in an AC circuit

The instantaneous power \mathcal{P}

$$\begin{aligned}\mathcal{P} &= i \Delta v = I_{\max} \sin(\omega t - \phi) \Delta V_{\max} \sin \omega t \\ &= I_{\max} \Delta V_{\max} \sin \omega t \sin(\omega t - \phi)\end{aligned}$$

The average power delivered by the source is converted to internal energy in the resistor

$$\mathcal{P}_{\text{av}} = \frac{1}{2} I_{\max} \Delta V_{\max} \cos \phi$$

$$\mathcal{P}_{\text{av}} = I_{\text{rms}} \Delta V_{\text{rms}} \cos \phi$$

$$\mathcal{P}_{\text{av}} = I_{\text{rms}}^2 R$$

If $\phi = 0, \cos \phi = 1$

$$\mathcal{P}_{\text{av}} = I_{\text{rms}} \Delta V_{\text{rms}}$$

The image features a blue gradient background with white circuit-like lines in the corners. The lines consist of straight segments connected by small circles, resembling a network or data flow diagram. The lines are positioned in the top-left, top-right, bottom-left, and bottom-right corners, framing the central text.

THANK FOR YOUR ATTENTION!