

Всеукраїнський науково-технічний журнал

Ukrainian Scientific & Technical Journal

ISSN 2306-8744

DOI: 10.37128/2306-8744-2021-2

# Вібрації в техніці та технологіях



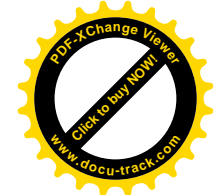
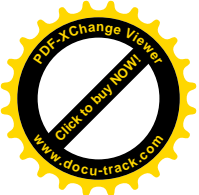

**Всеукраїнський науково-технічний журнал**

**Ukrainian Scientific & Technical Journal**

# **Вібрації в техніці та технологіях**

**№ 2 (101)**

**Вінниця 2021**

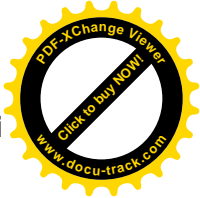
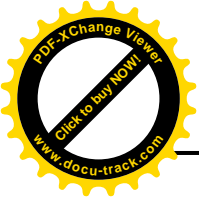
**ВІБРАЦІЇ В  
ТЕХНІЦІ ТА  
ТЕХНОЛОГІЯХ**

Журнал науково-виробничого та навчального  
спрямування Видавець: Вінницький національний  
аграрний університет

Заснований у 1994 році під назвою “Вібрації в техніці та  
технологіях”

*Свідоцтво про державну реєстрацію засобів масової  
інформації*

КВ № 16643-5115 ПР від 30.04.2010 р.

**Всеукраїнський науково-технічний журнал “Вібрації в техніці та технологіях” / Редколегія: Калетнік Г.М. (головний редактор) та інші. – Вінниця, 2021. – 2 (101) – 144 с.**

**Друкується за рішенням Вченої ради Вінницького національного аграрного університету (протокол №12 від 29.06.2021 р.)**

**Періодичне видання включено до Переліку наукових фахових видань України з технічних наук (Категорія «Б» Наказ Міністерства освіти і науки України від 02.07.2020 р. № 886)**

**Головний редактор**

**Калетнік Г.М.** – д.е.н., професор,  
академік НААН, Вінницький національний  
аграрний університет

**Заступник головного редактора**

**Адамчук В.В.** – д.т.н., проф., акад. НААН,  
Національний науковий центр “Інститут  
механізації та електрифікації сільського  
господарства”

**Відповідальний секретар**

**Солона О.В.** – к.т.н., доц., Вінницький  
національний аграрний університет

**Члени редакційної колегії**

**Булгаков В.М.** – д.т.н., професор, академік  
НААН, Національний університет  
біоресурсів і природокористування України

**Граняк В.Ф.** – к.т.н., доцент, Вінницький  
національний аграрний університет

**Деревенько І.А.** – к.т.н., доцент,  
Національний університет «Львівська  
політехніка»

**Зіньковський А.П.** – д.т.н., професор,  
Інститут проблем міцності імені Г. С.  
Писаренка НАН України

**Купчук І.М.** – к.т.н., доцент, Вінницький  
національний аграрний університет

**Матвєєв В.В.** – д.ф.-м.н., професор,  
академік НАН, Інститут проблем міцності  
імені Г.С. Писаренка НАН України

**Надуть В.П.** – д.т.н., професор, Інститут  
геотехнічної механіки імені М.С. Полякова  
НАН України

**Ольшанський В.П.** – д.ф.-м.н., професор,  
Харківський національний технічний  
університет сільського господарства імені  
Петра Василенка

**Полєвода Ю.А.** – к.т.н., доцент, Вінницький  
національний аграрний університет

**Севостьянов І.В.** – д.т.н., професор,  
Вінницький національний аграрний  
університет

**Твердохліб І.В.** – к.т.н., доцент, Вінницький  
національний аграрний університет

**Токарчук О.А.** – к.т.н., доцент, Вінницький  
національний аграрний університет

**Цуркан О.В.** – д.т.н. доцент, Вінницький  
національний аграрний університет

**Зарубіжні члени редакційної колегії**

**Максімов Джордан Тодоров** – д.т.н., проф., Технічний Університет Габрово (Болгарія)

Технічний редактор **Замрій М.А.**

Адреса редакції: 21008, Вінниця, вул. Сонячна 3, Вінницький національний аграрний університет, тел. 46 – 00– 03

Сайт журналу: <http://vibrojournal.vsau.org/>

Електронна адреса: [vibration.vin@ukr.net](mailto:vibration.vin@ukr.net)

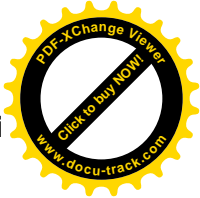
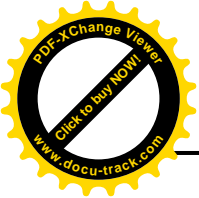
**З М І С Т****1. ТЕОРІЯ ПРОЦЕСІВ ТА МАШИН**

<i>Булгаков В. М., Солоня О. В., Ігнат'єв Є. І.</i> <b>ДОСЛІДЖЕННЯ ЯКІСНИХ ПОКАЗНИКІВ ФРОНТАЛЬНО НАВИШЕНОЇ ГИЧКОЗБИРАЛЬНОЇ МАШИНИ ПРИ КОЛИВАННЯХ У ПОВЗДОВЖНЬО-ВЕРТИКАЛЬНІЙ ПЛОЩИНІ</b> .....	5
<i>Севост'янов І. В., Мельник О. С., Краєвський С. О., Горбаченко А. А.</i> <b>ДОСЛІДЖЕННЯ ВІДЦЕНТРОВОГО ПОДРІБНЮВАЧА ЗЕРНОВОЇ СИРОВИНИ</b> .....	13
<i>Надутый В. П., Чолишкіна В. В., Курілов В. С.</i> <b>ИЗВЛЕЧЕНИЕ МИНЕРАЛЬНОГО СЫРЬЯ ЗАДАНОЙ КРУПНОСТИ И ПЛОТНОСТИ ИЗ ГОРНОЙ МАССЫ ВИБРАЦИОННЫМ МЕТОДОМ</b> .....	27
<i>Ольшанський С. В., Сліпченко М. В., Твердохліб І. В., Купчук І. М.</i> <b>КОЛИВАННЯ ІМПУЛЬСНО НАВАНТАЖЕНОГО ОСЦИЛЯТОРА З КВАДРАТИЧНИМ ОПОРОМ У СКЛАДІ ДИСИПАТИВНОЇ СИЛИ</b> .....	35
<i>Степаненко С. П., Котов Б. І., Грушецький С. М., Рудь А. В.</i> <b>МАТЕМАТИЧНЕ МОДЕЛЮВАННЯ РУХУ ЗЕРНОВОГО МАТЕРІАЛУ НА ПОВЕРХНІ ВІБРОЖИВИЛЬНИКА ЗА УМОВ ВВЕДЕННЯ ЙОГО В АСПІРАЦІЙНИЙ КАНАЛ СЕПАРАТОРА</b> ...46	
<i>Polievoda Y.</i> <b>APPLICATION OF VIBRATION EFFECTS IN BIOFUEL PRODUCTION</b> .....	56
<i>Граняк В. Ф., Гайдамак О. Л.</i> <b>НАБЛИЖЕНИЙ СПОСІБ РОЗРАХУНКУ ЗЕРНОПОТОКУ В ВЕРТИКАЛЬНОМУ ЦИЛІНДРИЧНОМУ ВІБРОРЕШЕТІ</b> .....	62
<i>Возняк О. М., Штуць А. А., Замрій М. А.</i> <b>РОЗРОБКА МІКРОПРОЦЕСОРНОГО КОНТРОЛЕРА ДЛЯ ВИМІРЮВАННЯ ЛІНІЙНОГО ПЕРЕМІЩЕННЯ РУХОМИХ ОРГАНІВ ВИКОНАВЧИХ МЕХАНІЗМІВ ВІБРАЦІЙНИХ МАШИН</b> ....	71

**2. МАШИНОБУДУВАННЯ ТА МАТЕРІАЛООБРОБКА**

<i>Котов Б. І., Грищенко В. О., Панцир Ю. І., Герасимчук І. Д.</i> <b>МАТЕМАТИЧНЕ МОДЕЛЮВАННЯ ДИНАМІЧНИХ РЕЖИМІВ ТЕПЛОАСОСНОЇ СИСТЕМИ ДЛЯ ТЕПЛОПОСТАЧАННЯ ТЕХНОЛОГІЧНИХ ОБ'ЄКТІВ</b> .....	85
<i>Сивак Р. І., Гунько І. В., Залізник Р. О.</i> <b>ЗАСТОСУВАННЯ ЛІНІЙ ТОКУ ПРИ ВИЗНАЧЕННІ КІНЕМАТИЧНИХ ХАРАКТЕРИСТИК В СТАЦІОНАРНИХ ПРОЦЕСАХ ПЛАСТИЧНОЇ ТЕЧІЇ МЕТАЛУ</b> .....	92
<i>Грицун А. В., Бабин І. А.</i> <b>ОБГРУНТУВАННЯ КОНСТРУКТИВНО-РЕЖИМНИХ ПАРАМЕТРІВ ДІЙКОВОЇ ГУМИ ПЕРЕМІННОГО ПЕРЕРІЗУ</b> .....	99
<i>Rutkevych V.</i> <b>INVESTIGATION OF TRANSITIONAL PROCESSES IN THE ADAPTIVE SYSTEM OF HYDRAULIC DRIVES OF THE MECHANISM FOR CUTTING AND UNLOADING STALK FODDER</b> .....	107
<i>Гайдамак О. Л., Гунько І. В., Паладій М. С.</i> <b>ДОСЛІДЖЕННЯ ШВИДКОСТІ РУХУ ПОРОШКОВИХ ЧАСТИНОК ХОЛОДНОГО ГАЗОДИНАМІЧНОГО НАПИЛЕННЯ</b> .....	115
<i>Trukhanska O</i> <b>IMPROVEMENT OF QUALITY INDICATORS OF THE PROCESS OF SOWING OF ROW CROPS</b> ..	124
<i>Руткевич В. С., Кушнір В. П.</i> <b>РОЗРАХУНОК НА МІЦНІСТЬ ДЕФОРМУЮЧИХ ЕЛЕМЕНТІВ ТА РОЗРОБКА КОНСТРУКЦІЙ ПРОШИВОК ДЛЯ ОБРОБКИ З НАКЛАДАННЯМ УЛЬТРАЗВУКУ</b> .....	135

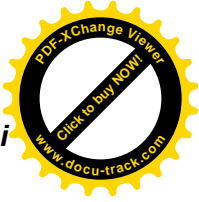
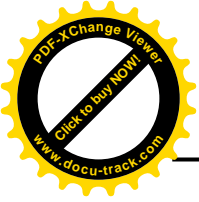
**Trukhanska O.**

PhD, Associate Professor

**Vinnytsia National Agrarian  
University****Труханська О. О.**

к.т.н., доцент

**Вінницький національний  
аграрний університет****УДК 631.33.024****DOI: 10.37128/2306-8744-2021-2-14****IMPROVEMENT OF QUALITY  
INDICATORS OF THE PROCESS  
OF SOWING OF ROW CROPS**

*The level of technology in agricultural production, the quality and cost of the products are largely determined by the degree of perfection of the machines and units used. In resolving this issue in our country and abroad, work is underway to identify rational ways of tillage, namely the minimum energy and labor costs per unit of crop production.*

*Improvement of tillage technology is carried out in two main directions: minimization of tillage and combination of several operations in one pass of the agricultural unit.*

*Along with the application of fertilizers, one of the important operations in the cultivation of crops is sowing, which is performed by seeders and combined tillage and sowing units.*

*Seeders for sowing row crops are a special group of sowing machines. The modern market of agricultural machinery offers a number of field units suitable for sowing with different tillage technologies.*

*The main working body of the drill, which determines the quality of sowing, is the sowing machine, and the opener group is the most important unit of the drill. It must remove lumps of soil from the row area, prepare the seedbed, lay the seeds on its dense bottom, maintain a given depth of its laying, ensure good contact of seeds with the soil, create a loose mulching layer. Despite their diversity, a universal combined device is needed that meets all agronomic and operational requirements for sowing seeds with different physical and mechanical properties.*

*The most promising in this aspect are vibrating sowing machines, in which uniform sowing of seeds and fertilizers is achieved by transmitting their mass of oscillating motions.*

*At vibration of loose material with a certain frequency and amplitude of oscillations friction forces between separate particles decrease, it becomes more fluffy, mobile.*

*The method of sowing crops is determined by the required sowing density and the order of placement of plants per unit area. There are spreading, row, nesting, dotted and stubble methods of sowing and planting crops.*

*The choice of sowing method largely depends on the sowing qualities of the seeds of the crop and soil and climatic conditions. Depending on this, the size of the row spacing and the distance between the plants is taken.*

**Keywords:** *quality, sowing, seeder, opener, seeds, soil, seed pipelines, sowing machine.*

**Introduction.** The main task of the sowing operation is to ensure the best conditions for seed germination and further development of plants, as well as to obtain their optimal density with uniform distribution over the feeding area [1].

Feeding area - the area of the field per plant - the most important indicator that determines the

yield and quality of products, the effectiveness of the crop against weeds. Many scientists have studied the effect of feeding area on yields, they proved experimentally that, when excessively thickened crops, one plant suppresses another, and when sparse - does not use the entire field area, which then grow weeds, all this leads to reduced yields.



The method of sowing crops is determined by the required sowing density and the order of placement of plants per unit area. There are spreading, row, nesting, dotted and stubble methods of sowing and planting crops. The combined method involves the simultaneous sowing of seeds and granular fertilizers. The choice of sowing method largely depends on the sowing qualities of the seeds of the crop and soil and climatic conditions. Depending on this, the row spacing and the distance between the plants are taken [1-6].

The main cereals - wheat, oats, rye, barley - are sown with a standard row spacing of 15 cm to obtain a more correct configuration of the seed feeding area (less elongated rectangle) also use narrower aisles 6 - 7 cm (narrow-row sowing). Row crops - corn, sugar beets, sunflowers, potatoes and others - sown (planted) with wide rows (wide-row sowing). Depending on the type of crop, the area of its cultivation and other factors, the width between rows varies between 45-90 cm and more [2, 3].

Opener groups, which are used, despite their diversity, do not fully ensure the implementation of agronomic requirements for sowing row crops, so the improvement of existing and development of fundamentally new sowing machines is relevant and will improve the quality of sowing

The economic efficiency of new agricultural machinery is determined by their impact on improving the final indicators of agricultural production, mainly on increasing profits by increasing yields, improving product quality, reducing labor costs and reducing production costs. In turn, reducing the cost of crop production largely depends on the cost of machinery and equipment, the cost of seeds and plant protection products, as well as the cost of operating the equipment used [3].

**Analysis of recent research and publications.** Depending on soil and climatic conditions, seeds are sown on a flat surface or profiled. The most common sowing on a flat surface. With excessive soil moisture, the seeds are wrapped on top of the ridges. In the arid zone, row seeds are sown in furrows to cover them in moist soil. On soils prone to wind erosion, they are sown on stubble, which protects young seedlings from the wind, and the soil - from warping.

Abroad, the sowing and planting schemes of some crops are somewhat different from the schemes used in our country. For example, cereals are sown in a row with rows of 15, 18 and 20 cm. Potatoes and seedlings are planted only in a row.

When nesting corn (USA), the width of the rows varies from 76.2 cm to 106.68 cm, and the width of the nests - from 36.8 cm to 106.68 cm [3, 5-8]. Crops and features of agricultural techniques for their cultivation necessitated the use of different methods of sowing. Any of these methods should provide each plant with a well-defined area of nutrition, which creates the most favorable conditions for plant growth and development in terms of providing the required amount of nutrients, moisture, light and heat. The feeding area should be optimal, which is determined by a scientifically sound seeding rate.

The main methods of sowing differ from each other by the uniform distribution of seeds, and then the plants by area.

Goal - the purpose is to study methods and improve the quality of sowing of sowing machines.

**Presenting main material.** The most important task in all the technology of cultivation of row crops is sowing and the quality and timeliness of it depends on the yield and quality of products, and in accordance with agronomic requirements. Agro technical requirements [5] are reduced mainly to the following: uniform distribution of seeds along the row; ensuring the following sowing rates for different crops; uneven sowing of seeds between individual devices should not exceed for cereals, flax and rice  $\pm 3\%$ , and for legumes  $\pm 4\%$ ; instability of sowing for all sown crops should not exceed  $\pm 2\%$ ; sowing fluctuations from the specified norm should not exceed  $\pm 3\%$  for all crops; preservation of sowing qualities (allowed damage to seeds of cereals and grasses 0.2%, legumes 0.7%); simplicity of design and manufacture. Currently, when cultivating row crops, pre-sowing tillage is carried out throughout the field, regardless of the location of the rows. At the same time tillage machines of the KPS-4 type (KPK-4) which have rigid frames to which working bodies fasten by means of a single-hinged suspension bracket are used. On bumps, when lifting, the working bodies become "on the heel" and deepen, and when lowered - "on the sock" and deepen. It is difficult to maintain the required stability of the processing depth. This leads to unfriendly, uneven seedlings.

Improvement of quality indicators is achieved through individual tillage of the row area, separating it from tillage in the rest of the area. At the same time, a four-link, parallelogram suspension of tillage working bodies should be used, which provides an aligned seed bed (Fig. 1) [5].

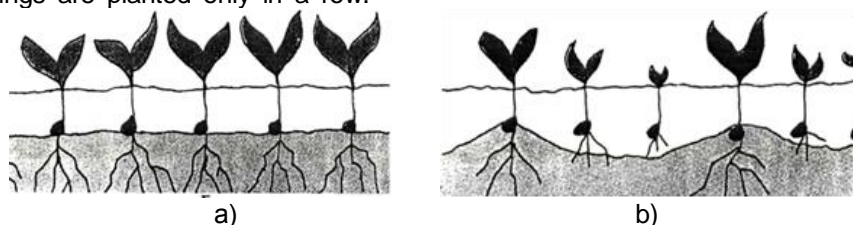
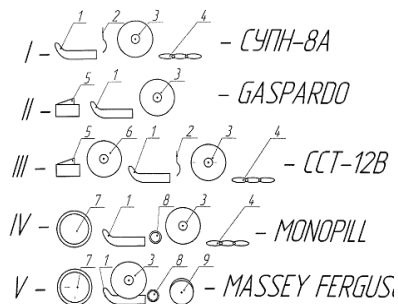

Fig. 1. Influence of pre-sowing cultivation on seedlings: a - qualitatively; b - poor quality.

It has been established that for volumetric contact of seeds with soil, which improves their swelling and germination, the size of soil lumps in the seed zone should not exceed 10 mm, commensurate with the size of sown seeds. To eliminate erosion processes, reduce evaporation of soil moisture and improve aeration, the size of lumps in the upper layer, above the seeds, should be 10 ... 16 mm, ie in the sowing area should create layers of soil with different fractional composition [8].

Sowing machines - dispensers that take a certain part of the seed (seeds, fertilizers) from the hopper, box and send it to the openers. The task of sowing machines is to create a uniform and continuous flow of seeds or fertilizers, to ensure the stability of its sowing regardless of the speed of the seeding unit, field relief, etc.

To meet the agronomic requirements, use different technological schemes of opener groups (Fig. 2).



**Fig. 2. Technological schemes of opener groups: I, II, III, IV, V - options: 1 - opener; 2 - wrapper; 3 - copying rolling roller; 4 - loop; 5 - lump separator; 6 - copying sealing roller; 7 - disk knife (coulter); 8 - suction wheel; 9 - V-shaped rolling roller.**

The simplest opener group includes: opener 1, wrapper 2, copy heavy roller 3 and loop 4. It is used on SUPN seed drills.

To maintain uniform seed wrapping depth, the opener group is equipped with a lump separator. To improve copying, two rollers are used: front 6 copy-sealing and rear 3 copy-rolling. Such a coulter group is used, for example, on beet seeders of the SST type.

On most drills the coulter group is connected to the drill frame by means of a parallelogram suspension [3].

On seeders establish, lump separators of various designs of such known manufacturers, as John Deere, Kinze, Massey Ferguson etc.

Wedge-shaped plate lump separators (Fig. 3) consist of two knives that remove the top layer of dry soil, or remove lumps, forming a flat surface.

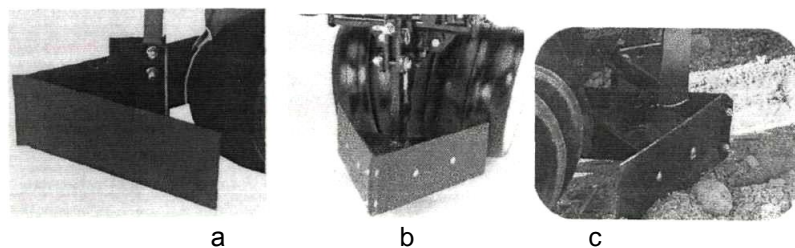

**Fig. 3. Wedge-shaped plate lump separators (a- John Deere, b - Kinze c -Massey Ferguson)**

The quality of lump separators determines the location of the copy rollers. Since in most cases, the copy rollers are placed at a distance from the lump separator, resulting in either the removal of the top layer of soil and the formation of a groove, or the preservation of lumps in the row area.

The lump separator (Fig. 4) is a roller, two vertical disks of which are connected by evenly spaced ribs. One disk is made in the form of a ring, in the center of the second is an axis with a bearing unit, while in the lower part of the hollow space of the roller is placed at an angle of attack and at an angle of roll plate blade, the rack of which is fixed on the axis, from the plate blade.

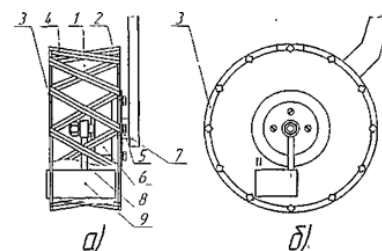
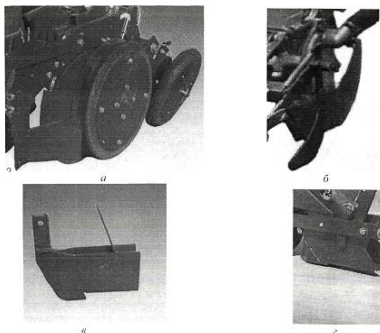

**Fig. 4. Lump separator of the opener group of a row seeder: a - lump separator, front view; b - lump separator, side view; 1 - skating rink; 2 - right vertical disk; 3 - left vertical disk; 4 - rib; 5 - axis; 6 - bearing assembly; 7- bracket; 8 - rack plate blade; 9 - plate blade.**

Different openers are used for sowing the seeds of row crops (Fig. 5): strip-shaped, keel-shaped, two-disc, belt.

Sliding openers form a groove due to the knife-shaped device, which smoothly passes into the cheeks. The cheeks do not allow the soil to crumble before the seeds "calm down" on the seedbed. Knife-shaped device makes a dense sowing bed, which improves the attraction of moisture to the seeds. However, the sliding opener does not make tight contact of the seed with the soil, and the seed after sowing has the ability to bounce, changing its position relative to the place of fall.

Wedge-shaped openers have a knife-shaped device, which compresses the soil, creating a dense seedbed, which promotes the inflow of moisture to the seeds. However, when meeting with large lumps, plant remains, such openers deepen, increasing the variability of the depth of seed wrapping.



**Fig. 5. Openers used for sowing row crops: a - two-disc; b - striped; c - keel-shaped; g - tape**

Disks when rotating, converge in front, forming a wedge. When the disks rotate during operation, they cut the soil and push it apart, forming a furrow.

However, in seed drills equipped with disc coulters, the seed drill is usually located high above the ground, so the height of the fall of the seed increases and, as a consequence, the coefficient of variation of the sowing step increases. In addition, a dense seedbed is not provided, which impairs seed germination [4].

Belt openers have the same design as slide-shaped, but they differ in that they have knife-shaped devices with different angles of entry.

The seed after leaving the sowing machine through the seed line enters the groove opened by the opener, where it under the action of elastic forces bounces, moves and thus deviates from the line of location of the seeds and from the point of loss. According to research, the coefficient of variation of

the sowing step at the working speed of the drill is 6.0 km / h, and a given sowing step of 12.0 cm is 50.5% [11].

Various technical devices are used to improve the quality of sowing (Fig. 6).

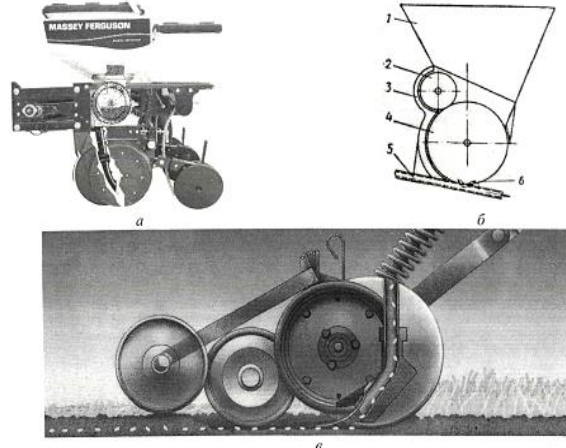

**Fig. 6. Sowing sections with devices for reducing the speed of rebound of seeds: a - seed line, directed in the direction opposite to the movement of the drill; b - sowing machine with transportation of seeds by air flow; c - the tip of the vas deferens in the form of a petal; 1 - bunker; 2 - clean the device; 3 - housing; 4 - porous seeding disc; 5 - tube for air supply; 6 - wedge-shaped seed ejector.**

Some manufacturers use seed lines directed in the direction opposite to the movement of the drill to dampen the rebound speed (Fig. 6, a).

Known sowing devices with the transportation of seeds by air flow (Fig. 6, b).

During operation, the seeds fall into the cell of the disk and are transported down, where the ejector directs them to the center of the tube, which creates an air flow. The ejector ensures the sequence and clarity of seed supply from the cells. However, these devices have not found practical application on drills due to the complexity of the design of the drill [10].

To quench the rate of rebound of seeds in the fall use the tips of the seed ducts in the form of a petal (Fig. 6, c).

A significant technological disadvantage of the opener group is the placement of the copy-rolling roller behind.

First, in front of it are the opener 1 and wrappers 2 (Fig. 7), which create an uneven micro relief of the surface and thus increase the variability of the oscillations of the rink in the vertical plane, and hence the variability of the depth of seed rapping.



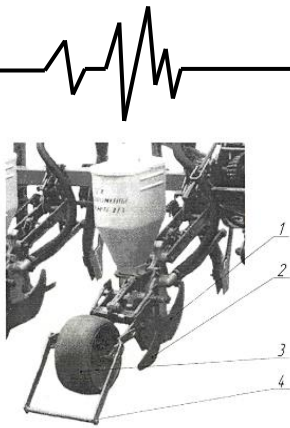
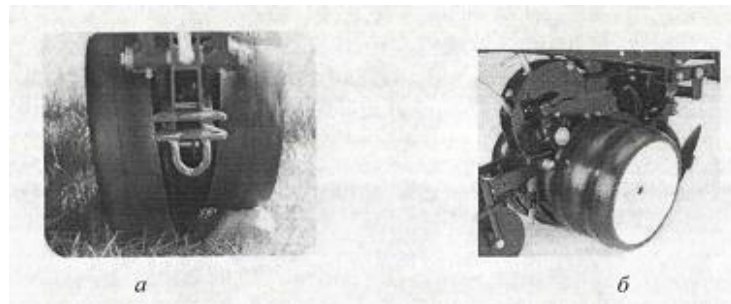

**Fig. 7. Seeder section SUPN - 8A: 1 - opener; 2 - wrapper; 3 - copying and rolling roller; 4 - loop**

Secondly, simultaneously with improvement of contact of seeds with soil, the top over a seed layer of soil is condensed.

Based on this, the best option is to place the copy rollers next to the opener (Fig. 8). Manufacturers install copying rollers with a movable suspension mechanism (Fig. 8, a), which allows each roller to move independently of each other.

For work on very loose fields where good possibility is required, establish double copying rollers (Fig. 8, b).



**Fig. 8. Location of copying rollers next to the opener: a - copying wheels with a movable suspension mechanism; b - double copying wheels.**

In order to improve the contact of seeds with the soil without compaction of the surface layer, some manufacturers of row seeders use a K-shaped

installation of solid (Fig. 9, a), finger (Fig. 9, b) rolling rollers, with recesses (Fig. 9, c) and flanges (Fig. 9, d).

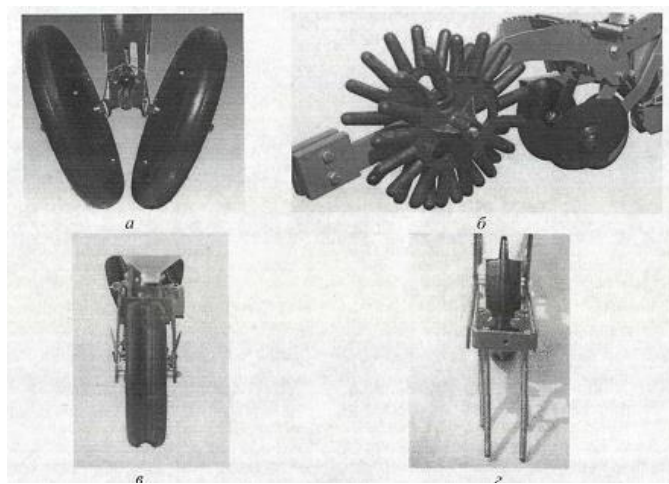

**Fig. 9. Rolling mills: a - K-shaped roller; b - finger sealing roller; c - sealing roller; d - heavy roller with restrictive flanges.**

However, in all cases of application of rollers over the seeds creates a compacted layer of soil. To improve the contact of seeds with the soil, it is desirable to press them into the soil while maintaining a loose finely lumpy layer on top.

Dense seedbed, improving the supply of moisture to the seeds from the lower layers of the soil, impairs the process of passage through it of the germinal root. It should be noted that in most opener groups there are no working bodies that fight seedlings and seedlings of weeds in the protective zones of the rows at the same time as sowing. This

leads to the need for mechanical pre-emergence tillage or pre-emergence (post-emergence) application of herbicides [4].

We can conclude that under the seeds should not be a flat surface, and a wedge-shaped subseed groove.

With existing sowing technologies, only post-sowing loosening of the soil to the depth of seed wrapping is possible. This requires additional costs and is technologically difficult to implement.

Based on the above, the improved working body should combine pre-sowing tillage with sowing,

make a wedge-shaped sub-seed furrow, pressing the seeds into the soil during sowing, to exclude surface rolling in the seed area.

Analysis of the development of sowing machines showed that for sowing mineral fertilizers, in the practice of agriculture used a large number of designs of sowing machines: chain, disk, disc, drum, star, butterfly, slot, screw, spiral and others. [3, 4].

All of them do not fully meet the agronomic requirements. They are characterized by insufficient uniformity of seeding and low suitability for working with fertilizers, have different properties, as well as the inability to adjust the seeding rate in a wide range without additional devices.

The need to use a large number of complex by design fertilizer spreaders was caused by the use of fertilizers with different mechanical properties. In recent years, solid nitrogen, phosphorus and complex mineral fertilizers are produced mainly in granular form. This allowed us to move to the use of devices of simpler design - coil-pin. Currently in our country on all combined drills for sowing cereals are installed devices of this type [9].

Having analyzed the sowing machines, it can be noted that the most promising in this aspect are vibrating sowing machines, in which uniform sowing of seeds and fertilizers is achieved by transferring their mass of oscillating motions.

When the bulk material vibrates with a certain frequency and amplitude of oscillations, the friction forces between the individual particles decrease, it becomes fluffier, mobile [5-7].

Analysis of the study of pre-sowing tillage and sowing of row crops allows us to conclude that the field germination of seeds and the friendliness of germination on the stability of seed wrapping depth, uniformity of seed distribution in a row, good seed contact with soil and sufficient aeration.

With the existing technologies of sowing row crops, the dispersion of the depth of seed wrapping is equal to the sum of the variances of random deviations: lump, copy wheel, opener, wrapper, rolling wheels, loop [9]. Achieving high stability of sowing depth with such a multifactorial dependence of this indicator is difficult. It is necessary to significantly reduce the number of factors by improving the technology of sowing

Water is needed for seed germination, because the seed germ consumes only soluble nutrients. Moisture rises to the seeds through the capillaries, to create which the seed bed must be sealed. In this case, in the area of the row should not be weed seedlings that shade cultivated plants and consume a significant amount of nutrients [11].

Good contact with the soil is required for the seeds to swell. The degree of contact depends on the fractional composition of the soil, the size of soil residues. Experiments have shown that the optimal size of soil lumps when sowing corn and sunflower is 1 ... 10 mm, beet 1 ... 5 mm, ie the size of soil lumps

should be comparable to the size of seeds, which provides volume contact with the soil.

The germination of seeds requires air, access to which the seeds must be free and constant. Germinating seeds absorb oxygen and emit carbon dioxide. For good aeration over seeds the loose layer of soil with a density of 0,7 ... 0,9 t / m<sup>3</sup> with the sizes of lumps no more than 10 mm is created. When soil fractions exceed these limits, the loss of moisture by convection-diffusion increases, especially at low humidity and high wind speeds, which occurs in spring and summer [3, 11].

Thus, it is possible to substantiate the technology of tillage in the area of rows, laying seeds in it and formulate the basic requirements for the developed opener group:

- creation of the leveled surface in a line zone, removal of lumps of soil before copying rollers;
- pruning of sprouts and seedlings of weeds in the protective zones of the row at the same time as sowing;
- the coefficient of variation of the distance between the seeds in a row (sowing step) is not more than 20%;
- coefficient of variation of the depth of seed wrapping up to 10%;
- deviation from the line line up to 10 mm;
- soil density in the seed zone 1.1 ... 1.25 t / m<sup>3</sup>, above the seeds - 0.7 ... 0.9 t / m<sup>3</sup>.

The process of laying seeds when sowing row crops (sunflower and corn) for the developed working body can be represented in three stages (Fig. 10).

The first stage includes - trimming and raising the surface layer of the deformer soil to the depth of sowing without shifting to the sides and tilting. At the same time the seedbed is compacted and a wedge-shaped groove is cut in it.

The second stage is the movement of seeds to the bottom of the formed wedge-shaped subseed groove and their pressing into the soil.

The third stage - sprinkling the seeds with a raised loose layer of soil and leveling the surface.

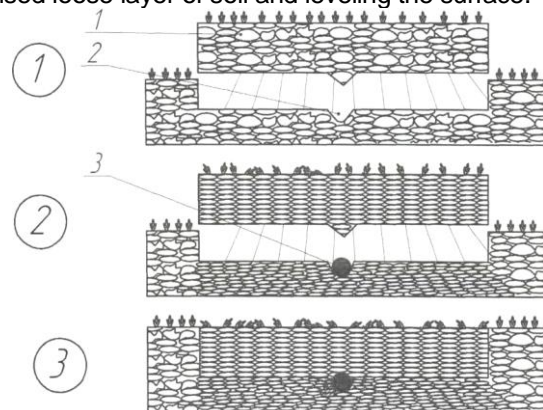
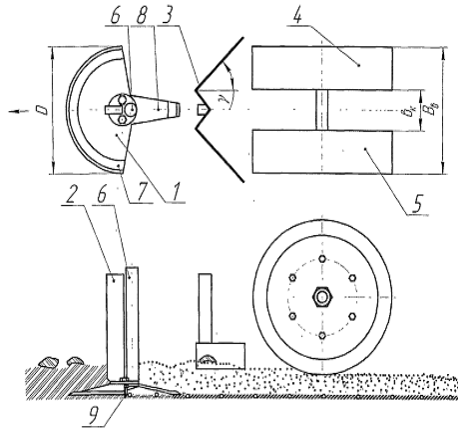

Fig. 10. Technological scheme of wrapping the seeds of row crops (corn and sunflower) using the working body of the row seeder.

To implement such a technological scheme, a multifunctional opener group is proposed (Fig. 11).



**Fig. 11. Scheme of the multipurpose opener group of a row seeder: 1 - a plate opener; 2 - stable; 3 - lump separator - equalizer; 4,5 - the right and left parts of a copying roller; 6 - seminal vesicle; 7 - horizontal lunch; 8 - ending; 9 - knife-shaped device.**

In order to avoid the soil entering the sucker space under the action of force  $F$  (Fig. 12, a), a horizontal rim of width  $e$  is made. In the presence of a horizontal rim, the resulting force  $F$  is excluded (Fig. 12).

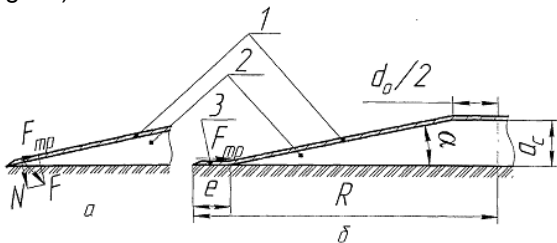

**Fig. 12. The scheme of influence of soil on a blade of a plate opener: a - without a rim; b - with a rim; 1 - plate opener; 2 - space under the opener; 3 - horizontal lunch; e - rim width.**

The task of the plate opener is to cut the formation, self-made sowing furrow with the least soil displacement. This function is performed by flat-cutting paws with a crushing angle  $\alpha = 10 \dots 12^\circ$ . As can be seen from (Fig. 12):

$$\operatorname{tg} \alpha = \frac{a_c}{R - 0,5d_0 - e} \quad (1)$$

where  $a_c$  is the height of the sucker space,  $a_c = 0.12$  mm

$R$  is the radius of the plate opener, mm;  $d_0$  is the diameter of the base of the plate opener, mm;  $e$  is the width of the horizontal rim, mm

For fastening of a rack of a seed tube it is necessary; that  $d_0 = 55$  mm.

The height of the sucker space, taking into account the size of the largest seeds of sunflower

and corn and the presence of subseed groove  $a_c = 0.12$  mm.

Then the width of the rim [7]:

$$e = R - R - 0,5d_0 - \frac{a_c}{\operatorname{tg} \alpha} \quad (2)$$

We accept  $e = 20$  mm. The thickness of the material based on the conditions of strength and taking into account the width of the plate opener, take equal to 4 mm. We choose steel 65G as a material for production of a plate opener.

Sharpening of a working edge of a plate opener is defined by a crushing angle. For a plate opener with an angle  $\alpha < 15^\circ$  the top delay and sharpening is applied. The sharpening angle is  $12 \dots 15^\circ$ . The thickness of the cutting edge of the blade after sharpening should not exceed 0.3 mm [7].

To give the plate opener the ability to self-sharpen during operation, its blade is made by two-layer surfacing on the base material of the disc opener on the back side of a wear-resistant alloy, such as somite.

After leaving the seed line, the seed is in flight, flying under the action of inertia and gravity in the horizontal projection path  $l_1$  (Fig. 13). When falling into the subseed furrow, the seed under the action of part of the kinetic energy and elasticity jumps moving to a length of  $l_2$ . Then it is affected by the conical plane of the plate opener at a distance of  $l_3$  and the horizontal rim -  $l_4$  [7].

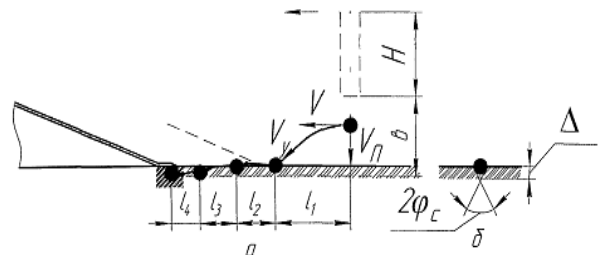

**Fig. 13. Deviation of seeds along a line from a point of their falling out from a seed line: a - a zone of movement of seeds; b - scheme of seed placement in the subseed furrow.**

Total deviation of seeds from the point of loss:

$$l = l_1 + l_2 + l_3 + l_4 \quad (3)$$

where  $l_1$  - distance of movement from the point of seed loss to its first contact with the soil:

$$l_1 = \frac{Va}{\sqrt{2g(H + a + \Delta)}} \quad (4)$$

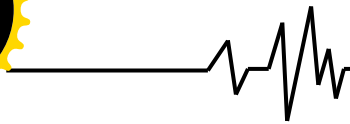
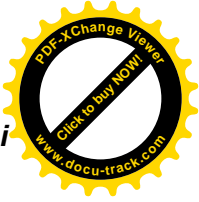
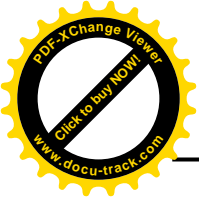

where H-length of the vas deferens;  $\Delta$  - depth of subseed furrow  $l_2$  is the distance of movement as a result of bouncing and rolling along the drill:

$$l_2 = \frac{\beta(R - e - 0.5d_0)}{V} \cdot \sqrt{V^2 + 2g(H + a + \Delta)} \quad (5)$$

where  $\beta$  – the rate of recovery of seeds on impact; R - radius of a plate opener.

$l_3$ - distance of movement as a result of influence of the conical plane of a plate opener:

$$l_3 = [(a_c + \Delta) - d] \cdot \text{tg}(\alpha + \varphi_c) \quad (6)$$

$$l = \frac{Va}{\sqrt{2g(H + a + \Delta)}} + \frac{\beta(R - e - 0.5d_0)}{V} \cdot \sqrt{V^2 + 2g(H + a + \Delta)} + [(a_c + \Delta) - d] \cdot \text{tg}(\alpha + \varphi_c) + \frac{(f_n - f_c) \cdot (d - \Delta) \cdot e}{d} \quad (8)$$

The obtained formula connects the main design parameters, technological properties of soil, seeds and allows to determine the deviation l depending on the operating conditions, the speed of the drill [7-11].

The method of exposure of the disc opener to the soil differs from the method of exposure of the sliding opener.

The plate opener cuts and partially crushes, by compression, the cut layer of soil.

Sliding opener, cuts a groove, me, presses the soil, forming a compacted bottom and walls.

The force of resistance of the opener movement in the soil in accordance with the theory of Academician V. Goryachkin can be represented in general:

$$F_e = qSh(1 + f_c) = q \frac{\pi d^2}{4} h(1 + f_c) \quad (9)$$

where q – coefficient of volumetric crushing of the soil, S – seed cross-sectional area.

Efforts to separate seeds from the soil after pressing:

$$F_{\text{відп}} = q \frac{1}{6} \pi d^3 f_c \frac{1}{\varepsilon} \cdot \frac{d - \Delta}{d} \quad (10)$$

where  $F_{\text{відп}}$  – the force of separation of seeds from the soil after compaction,

$\varepsilon$  – coefficient that takes into account the effect of speed.

$\alpha$  - crumbling angle (inclination of the generator);  $\varphi_c$  - angle of friction of seeds on a steel surface; d - equivalent seed diameter, a, b, c - average values of length, width, thickness of seeds.

$l_4$  - the distance of movement under the influence of the horizontal rim of the plate opener:

$$l_4 = \frac{(f_n - f_c) \cdot (d - \Delta) \cdot e}{d} \quad (7)$$

where  $f_n$ ,  $f_c$  – coefficients of friction of seeds on a steel surface and on soil accordingly.

Deviation of seeds from the point of falling out of the vas deferens before it is pressed into the soil:

Efforts to separate seeds from the soil  $F_{\text{відп}} > F_T + F_{\text{П}}$

$F_T$ ,  $F_{\text{П}}$  – gravity and adhesion.

The method of impact on the soil:

- for a plate opener:

$$F_{TB} = kDa\varepsilon + m_{TB} g f_1 \quad (11)$$

- for a sliding opener:

$$F_{TK} = qhb_c e_c \varepsilon + m_{TK} g f_1 \quad (12)$$

Pressing the seeds into the soil with a moisture content of 18% eliminates damage to the seeds and ensures close contact with the soil.

According to [5]: the ratio of the mass of moisture contained in the seeds to the mass of absolutely dry seeds, expressed as a percentage.

$$W_a = \frac{m_s - m_c}{m_c} 100\% \quad (13)$$

where  $m_s$  - the mass of moisture contained in the seeds;

$m_c$  - mass of absolutely dry seeds.

Seed moisture has the most significant effect on their physical and mechanical properties.

Seed density is found by:



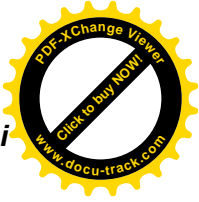
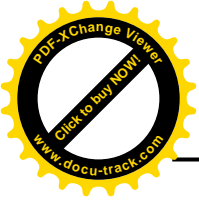

$$\rho_H = \frac{m_c}{V_H}, \quad (14)$$

$$V_H = V_{BH} - V_B, \quad (15)$$

where  $V_H$  – volume of water squeezed from seeds,  $sm^3$ ;

$V_{BH}$  – volume of water with seeds,  $sm^3$ ;

$V_B$  – volume of water without seeds,  $sm^3$ .

The bulk density of the seeds is found by:

$$\rho_{nac} = \frac{m_c}{V_{nac}}, \quad (16)$$

Frictional properties of seeds and soil are determined in accordance with [10]. The maximum angle  $\alpha_n$  at which the sample still remains at rest is equal to the angle of friction  $\varphi_{tr}$ . The tangent of the angle  $\alpha_n$  and equal to the coefficient of friction at rest  $f_n$ .

The friction force  $F$  is proportional to the normal pressure  $N$  and is determined:

$$F = Ntg\alpha = Ntg\varphi_{mp} = Nf_n \quad (17)$$

The coefficient of friction in the movement  $f_p$  with the relative movement of seeds on the surface at a speed close to the working is determined:

$$f_p = tg\alpha_n - \frac{2S}{gt^2 \cos\alpha_n}, \quad (18)$$

where  $\alpha_n$  - the angle of inclination of the plane, when moving the seeds, deg;

$S$  - the path traveled by the seeds during the experiment, m;

$t$  - the path traveled by the seed time, during which the sample passed the path during the experiment, sec.

Seeds when pressed into the soil are exposed to the opener and the soil. As a result of this exposure, they can be damaged or completely destroyed. As a result, the sowing properties of the seed deteriorate. Therefore, it is necessary to know what effort is required to destroy the seeds in three planes (length, width, height).

The force of pressing the seeds into the soil is necessary to find out whether it exceeds the force of destruction of the seeds in three directions: width, height and thickness. Simultaneously with the determination of the pressing force, the density of contact of the seed with the soil is determined, which may be characterized by the specific force of its separation from the soil after pressing. The greater this effort, the higher the contact density. Seeds when falling

can "jump", fly away, resulting in changes in the distance between the seeds, they deviate from the line. All these deviations are a consequence of the elasticity of the seeds and depend on the size, shape, species, intensity of interaction [5-8].

The coefficient of recovery of seeds when they hit a metal surface, a flat surface of the soil and a conical groove cut in the soil is determined:

$$K = \sqrt{\frac{h_2}{h_1}}, \quad (19)$$

where  $K$  - recovery factor;  $h_1$  - initial height, m;  $h_2$  - jump height, m.

On the basis of theoretical research, it is established that the process of wrapping seeds in the soil is influenced by two factors:

1. The speed of the drill  $V$ , m / s;
2. Depth of subseed groove  $\Delta$ , m.

**Conclusions.** The coulter groups of row seeders do not fully meet the agronomic requirements: the coefficient of variation of the distance between the seeds in a row exceeds 20%, the surface rolling of the row by a copying roller does not fully meet the conditions of seed germination, weeding does not destroy weeds.

To create a tight contact of seeds with the soil, they must be pressed immediately after leaving the seed line, leaving a loose layer over the seeds.

The proposed scheme of the multifunctional opener group, which consists of a plate opener, lump separator - leveler, roller, ploughshare, will improve the quality of sowing of row crops and will allow to lay the seeds by pressing it into the subseed groove, perform row removal and soil compaction over it.

The main factors influencing the deviation of the seed from the point of loss are the speed of the drill and the depth of the sub-seed furrow.

### References

1. Kaletnik, H.M., & Adamchuk, V.V., & Petrychenko, Ye.A., & Bulhakov, V.M., & Kuvachov V.P. (2017). Teoriia ploskoparalelnoho rukhu udobriualno-posivnoho mashynno-traktornoho ahrehatu [Vseukrainskyi naukovotekhnichniy zhurnal] «Tekhnika, enerhetyka, transport APK», 2 (97), 6-18 [in Ukrainian].
2. Shustyk, L., & Marynyna, L. (2016) Sivalky prosapnykh kultur: konstruktyvni osoblyvosti. Propozytsiia - Holovnyi zhurnal z pytan ahrobiznesu, Retrieved from <https://propozitsiya.com/seyaliki-propashnyh-kultur-konstruktyvnye-osobennosti> [in Ukrainian].
3. Shvets, L.V., & Sydorenko, V.Iu. (2013) Ohliad isnuichykh konstrukttsii soshnykiv. [Materialy VII shchorichnoi naukovotekhnichnoi



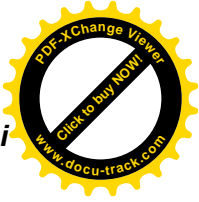
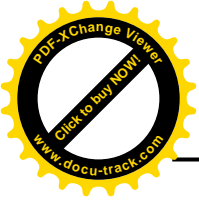

studentskoi konferentsii fakultetu mekhanizatsii silskoho hospodarstva] «Perspektyvy rozvytku silskohospodarskoi tekhniky», 131-133 [in Ukrainian].

4. Trukhanska, O.O. (2019) Vplyv faktoriv peredposivnoho obrobittu na vlastyvoli nasinnievoho lozha hruntu. [Materialy V Vseukrain. nauk.-prakt. konf.] «Perspektyvy i tendentsii rozvytku konstruksii ta tekhnichnoho servisu silskohospodarskykh mashyn i znariad», Zhytomyr. ahrotekhn. koledzh, 248-250 [in Ukrainian].

5. Voitiuk, D.H., & Havryliuk, H.R. (1994) Silskohospodarski mashyny. K.: Urozhai, [in Ukrainian].

6. Adamchuk, V., & Bulgakov, V., & Gorobey V. (2016) Theory of two-disc anchor opener of grain drill [Scientific and technical union of mechanical engineering] International scientific conference «Conserving soils and water» , 71-74 [in English].

7. Kaletnik, H.M. & Zaryshniak, A.S., & Adamchuk, V.V., & Bulhakov, V.M. (2013) Zemlerobskia mekhanika – teoretychna baza suchasnoi zemlerobskoi tekhniky [Mekhanizatsiia ta elektryfikatsiia silskoho hospodarstva: mizh vid. temat. nauk. zb.] Hlevakha, 98, 31- 44 [in Ukrainian].

8. Bulhakov, V.M. & Babytskyi, L.F., & Voitiuk, D.H. (1999) Osnovy nauchnykh issledovanyi [in Russian].

9. Bulgakov, V., & Adamchuk, V., & Gorobey, V (2016) Theory of the oscillations of atoothed disk opener during its movement across srregularities of the soilsurface. Agronomy Research, 3, 711-724 [in English].

10. Bulhakov, V.M., & Horobei, V.P. (2016) Vdoskonalennia konstruksii kombinovanoho dvodyskovokankernoho soshnyka. Visnyk ahrarnoi nauky . Kyiv, 4, 57-64 [in Ukrainian].

11. Bulhakov, V.M. & Holovach, I.V., & Horobei, V.P., & Sviren, O.M. (2015) Pobudova matematychnoi modeli kolyvalnoho rukhu u grunti zubchastoho soshnyka selektsiinoi sivalky [Konstruiuvannia, vyrobnytstvo ta ekspluatatsiia silskohospodarskykh mashyn] Zahalnodержavnyi mizhvidomchyi naukovo-tekhnichniy zbirnyk KNTU, 45, 50-62 [in Ukrainian].

#### ПОВЫШЕНИЕ КАЧЕСТВЕННЫХ ПОКАЗАТЕЛЕЙ ПРОЦЕССА ПОСЕВА ПРОПАШНЫХ КУЛЬТУР

Уровень технологий в сельскохозяйственном производстве, качество и себестоимость получаемой продукции во многом определяются степенью усовершенствования используемых машин и агрегатов. В решении этого вопроса в нашей

стране и за рубежом ведутся работы по выявлению рациональных способов обработки почвы, а именно минимум энергетических и трудовых затрат на единицу продукции растениеводства.

Совершенствование технологии обработки почвы осуществляется двумя основными направлениями: минимизация обработки почвы и сочетание нескольких операций за один проход сельскохозяйственного агрегата.

Наряду с внесением удобрений, одной из важных операций при обработке культур является посев, что выполняется сеялками и комбинированными почвообрабатывающими и высевальными агрегатами.

Сеялки для посева пропашных культур представляют особую группу посевных машин. Современный рынок сельскохозяйственной техники предлагает целый ряд полевых агрегатов, пригодных для проведения посева при различных технологиях обработки почвы.

Основным рабочим органом сеялки, определяющим качество сева, является высевной аппарат, а сошниковая группа - важнейший узел сеялки. Она должна удалять комки почвы с зоны борозды, готовить посевное ложе, улаживать семена на его плотное дно, выдерживать заданную глубину его заложения, обеспечивать хороший контакт семян с почвой, создавать рыхлый мульчирующий слой. Несмотря на их многообразие, необходим универсальный комбинированный аппарат, удовлетворяющий всем агротехническим и эксплуатационным требованиям посева семян с различными физико-механическими свойствами.

Наиболее перспективными в этом отношении являются вибрационные посевные аппараты, в которых равномерный посев семян и туков достигается передачей их массе колебательных движений.

При вибрации сыпучего материала с определенной частотой и амплитудой колебаний снижаются силы трения между отдельными частицами, он становится более разрыхленным, подвижным.

**Ключевые слова:** качество, посев, сеялка, сошник, семена, почва, семяпровод, высевной аппарат.

#### ПІДВИЩЕННЯ ЯКІСНИХ ПОКАЗНИКІВ ПРОЦЕСУ СІВБИ ПРОСАПНИХ КУЛЬТУР

Рівень технологій у сільськогосподарському виробництві, якість і собівартість одержуваної продукції багато в чому визначаються мірою досконалості використовуваних машин і агрегатів. У

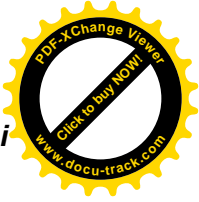
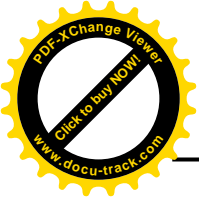

вирішенні цього питання у нашій країні й за кордоном ведуться роботи з виявлення раціональних способів обробки ґрунту, а саме мінімум енергетичних і трудових витрат на одиницю продукції рослинництва.

Удосконалення технології обробки ґрунту здійснюється двома основними напрямками: мінімізація обробки ґрунту й поєднання декількох операцій за один прохід сільськогосподарського агрегату. Цільовою функцією ефективності технології обробки ґрунту є мінімум енергетичних і трудових витрат на одиницю продукції рослинництва.

Однією з важливих операцій при обробці культур, поряд із внесенням добрив, є сієба, що виконується сієлками і комбінованими ґрунтообробними і висівними агрегатами.

Сучасний ринок сільськогосподарської техніки пропонує цілий ряд польових агрегатів, придатних для проведення висіву при різних технологіях обробки ґрунту. Сієлки для сієби просапних культур представляють особливу групу посівних машин.

Основним робочим органом сієлки, що визначає якість сієби, є висівний апарат, а

сошнікова група – найважливіший вузол сієлки. Вона повинна видаляти грудки ґрунту з зони рядка, готувати посівне ложе, укласти насіння на його щільне дно, витримувати задану глибину його закладання, забезпечувати добрий контакт насіння з ґрунтом, створювати пухкий мульчуючий надрасінневий шар. Незважаючи на їх різноманіття, необхідним є застосування універсального комбінованого апарату, що задовольняє всім агротехнічним і експлуатаційним вимогам висіву насіння з різними фізико-механічними властивостями.

Найбільш перспективними в цьому аспекті є вібраційні висівні апарати, в яких рівномірне висівання насіння і туків досягається передачею їх масі коливальних рухів.

При вібрації сипкого матеріалу з певною частотою і амплітудою коливань знижуються сили тертя між окремими частинками, він становиться більш розпушеним, рухомим.

**Ключові слова:** якість, сієба, сієлка, сошник, насіння, ґрунт, насіннепроводи, висівний апарат.

#### **Відомості про авторів**

**Труханська Олена Олександрівна** – кандидат технічних наук, доцент, доцент кафедри агроінженерії та технічного сервісу Вінницького національного аграрного університету (вул. Сонячна, 3, м. Вінниця, 21008, Україна, e-mail: [seaswallow@ukr.net](mailto:seaswallow@ukr.net)).

**Труханская Елена Александровна** - кандидат технических наук, доцент, доцент кафедры Агроинженерия и технического сервиса Винницкого национального аграрного университета (ул. Солнечная, 3, г. Винница, 21008, Украина, e-mail: [seaswallow@ukr.net](mailto:seaswallow@ukr.net)).

**Olena Trukhanska** – Candidate of Technical Sciences, Associate Professor, Associate Professor of the Department of Agroengineering and Technical Service of Vinnytsia National Agrarian University (Solnechnaya St., 3, Vinnytsia, 21008, Ukraine, e-mail: [seaswallow@ukr.net](mailto:seaswallow@ukr.net)).